

Express 3000

Part Number 1203153L2

Document Number 61203153L2-20A

May 1999

1203153L2 Express 3000, Two Phone Ports

336012VUR01 Express 3000 Power Supply, 12 VDC Output

Trademarks

Expert ISDN is a trademark of ADTRAN, Inc. (patent #5,715,241). Express 3000 and Express Configuration Software are trademarks of ADTRAN, Inc.

Hayes is a registered trademark of Hayes Microcomputer Products, Inc.

HyperTerminal is a registered trademark of Hilgraeve, Inc.

MicroPhone Pro is a trademark of Software Ventures Corporation.

Windows is a registered trademark and Windows NT is a trademark of Microsoft Corporation.

The Express 3000 incorporates Synchronous Data Compression based on either IBM or hi/fn proprietary intellectual property depending on the time of manufacture. The following trademarks and copyrights are applicable:

Stacker LZS Compression

Copyright © 1989 Carnegie Mellon University

All rights reserved.

Redistribution and use in source and binary forms are permitted provided that the above copyright notice and this paragraph are duplicated in all such forms and that any documentation, advertising materials, and other materials related to such distribution and use acknowledge that the software was developed by Carnegie Mellon University. The name of the University may not be used to endorse or promote products derived from this software without specific prior written permission. This software is provided "as is" and without any express or implied warranties, including, without limitation, the implied warranties of merchantability and fitness for a particular purpose.

hi/fn
5993 Avenida Encinas
Carlsbad, CA



ADTRAN

Explorer Boulevard
P.O. Box 140000
Huntsville, AL 35814-4000
Phone: (256) 963-8000

© 1999 ADTRAN, Inc.
All rights reserved.
Printed in USA.

ADTRAN Year 2000 (Y2K) Readiness Disclosure

ADTRAN has established a Year 2000 program to ensure that our products will correctly function in the new millennium. ADTRAN warrants that all products meet Year 2000 specifications regardless of model or revision. Information about ADTRAN's Year 2000 compliance program is available at the following:

Product Matrix	www.adtran.com/y2kfax.html <i>Lists Y2K plans and product certifications.</i>
E-mail	year2000@adtran.com
Faxback	(256) 963-8200
Document Line	<i>See also Product Matrix, above.</i>
Y2K Project Line	(256) 963-2200

Important Safety Instructions

When using your telephone equipment, basic safety precautions should always be followed to reduce the risk of fire, electric shock and injury to persons. These precautions are listed below.

1. Do not use this product near water (for example, near a bath tub, wash bowl, kitchen sink or laundry tub, in a wet basement, or near a swimming pool).
2. Avoid using a telephone (other than a cordless type) during an electrical storm. There may be a remote risk of electric shock from lightning.
3. Do not use the telephone to report a gas leak in the vicinity of the leak.
4. Use only the power cord or power supply indicated in the manual. Check local codes for any special disposal instructions.

SAVE THESE INSTRUCTIONS.

FCC regulations require that the following information be provided in this manual:

1. This equipment complies with Part 68 of the FCC rules. On the bottom of the equipment housing is a label that shows the FCC registration number and Ringer Equivalence Number (REN) for this equipment. If requested, provide this information to the telephone company.
2. If this equipment causes harm to the telephone network, the telephone company may temporarily discontinue service. If possible, advance notification is given; otherwise, notification is given as soon as possible. The telephone company will advise the customer of the right to file a complaint with the FCC.
3. The telephone company may make changes in its facilities, equipment, operations, or procedures that could affect the proper operation of this equipment; advance notification and the opportunity to maintain uninterrupted service is given.
4. If experiencing difficulty with this equipment, please contact ADTRAN for repair and warranty information. The telephone company may require this equipment to be disconnected from the network until the problem is corrected or it is certain the equipment is not malfunctioning.
5. This unit contains no user-serviceable parts.
6. An FCC-compliant telephone cord with a modular plug is provided with this equipment. This equipment is designed to be connected to the telephone network or premises wiring using an FCC-compatible modular jack, which is Part 68 compliant.
7. The following information may be required when applying to the local telephone company for leased line facilities.

Service Type	Digital Facility Interface Code	Service Order Code	Network Jacks
ISDN	021S5	6.0F	RJ-45

Federal Communications Commission Radio Frequency Interference Statement

This equipment has been tested and found to comply with the limits for a Class B digital device, pursuant to Part 15 of the FCC Rules. These limits are designed to provide reasonable protection against harmful interference when the equipment is operated in a commercial environment. This equipment generates, uses, and can radiate radio frequency energy and, if not installed and used in accordance with the instructions, may cause harmful interference to TV or radio reception, which can be determined by turning the equipment on and off. The user is encouraged to try to correct the interference by one or more of the following methods:

- Reorient or relocate the receiving antenna.
- Increase the separation between the equipment and receiver.
- Connect the equipment into an outlet on a circuit different from that to which the receiver is connected.
- Consult the dealer or an experienced radio/TV technician for help.

WARNING

Changes or modifications to this unit not expressly approved by ADTRAN will void the user's authority to operate the equipment.

Canadian Emissions Requirements

This digital apparatus does not exceed the Class B limits for radio noise emissions from digital apparatus as set out in the interference-causing equipment standard entitled "Digital Apparatus," ICES-003 of the Department of Communications.

Cet appareil numérique respecte les limites de bruits radioélectriques applicables aux appareils numériques de Class B prescrites dans la norme sur le matériel brouilleur: "Appareils Numériques," NMB-003 édictée par le ministre des Communications.

Canadian Equipment Limitations

NOTICE: The Canadian Industry and Science Canada label identifies certified equipment. This certification means that the equipment meets certain telecommunications network protective, operational, and safety requirements. The Department of Communications does not guarantee the equipment will operate to the user's satisfaction.

Before installing this equipment, users should ensure that it is permissible to be connected to the facilities of the local telecommunications company. The equipment must also be installed using an acceptable method of connection. In some cases, the company's inside wiring associated with a single line individual service may be extended by means of a certified connector assembly (telephone extension cord). The customer should be aware that compliance with the above conditions may not prevent degradation of service in some situations.

Repairs to certified equipment should be made by an authorized Canadian maintenance facility designated by the supplier. Any repairs or alterations made by the user to this equipment, or equipment malfunctions, may give the telecommunications company cause to request the user to disconnect the equipment.

Users should ensure for their own protection that the electrical ground connections of the power utility, telephone lines, and internal metallic water pipe system, if present, are connected together. This precaution may be particularly important in rural areas.



Users should not attempt to make such connections themselves, but should contact the appropriate electric inspection authority, or an electrician, as appropriate.

The Load Number (LN) assigned to each terminal device denotes the percentage of the total load to be connected to a telephone loop which is used by the device, to prevent overloading. The termination on a loop may consist of any combination of devices subject only to the requirement that the total of the Load Numbers of all devices does not exceed 100.

WARRANTY: ADTRAN warrants that items manufactured by ADTRAN and supplied under Buyer's order shall be free from defects in materials and workmanship and will conform to applicable specifications and drawings. ADTRAN's liability herein, whether based upon breach of warranty or contract or negligence in manufacture, shall be limited to replacement or repair at ADTRAN's election of all such defective or nonconforming items, provided that this warranty shall apply only where Buyer has given ADTRAN written notice of such defects or nonconformity within five (5) years* after delivery by ADTRAN of such items to Buyer. ADTRAN shall have the right prior to return to inspect at Buyer's plant any items claimed to be defective or nonconforming.

***Note:** The following items carry warranty period as shown.

1. Items not of ADTRAN manufacture will carry the remaining warranty and related terms and conditions of the original manufacturer.
2. Encapsulated U-Repeater and Encapsulated DDS Repeater—two years.

The foregoing constitutes the sole and exclusive remedy of the Buyer and exclusive liability of ADTRAN AND IS IN LIEU OF ANY AND ALL OTHER WARRANTIES EXPRESSED OR IMPLIED OR STATUTORY AS TO MERCHANTABILITY, FITNESS FOR PURPOSE SOLD, DESCRIPTION, QUALITY, PRODUCTIVENESS OR ANY OTHER MATTER. Without limiting the foregoing, in no event shall ADTRAN be liable for the loss of use or profit or other collateral, special or consequential damages.

RETURNS: Return authorization must be obtained from ADTRAN prior to return of any items, including those for repair. Buyer's right to repair or replacement is governed by this Warranty. Issuance of credit for returned items shall be made at ADTRAN's discretion upon Buyer's request. All returns for credit accepted by ADTRAN are subject to a restocking fee.

SHIPPING: The cost of shipping the equipment from Buyer's facility back to ADTRAN shall be paid by the Buyer. The cost for return shipping of the equipment by surface carrier shall be paid by ADTRAN. ADTRAN will utilize other means of express shipment at the request of the Buyer. The cost of shipping shall be paid by the Buyer if express

shipment is requested. In-warranty equipment returned for repair that is found not defective will carry a nominal charge to cover handling cost.

OUT OF WARRANTY: The cost of out-of-warranty repairs including return shipment are subject to a charge as quoted by ADTRAN. The cost of the repair will be invoiced and the return of the item will be made using the most economical shipment means available. ADTRAN will use other means of express shipment at the request of the Buyer. In this case, the cost of shipping shall be paid by the Buyer.

ALTERATION TO EQUIPMENT PURCHASED: Modification or alteration to purchased equipment by Buyer, other than that specifically authorized by this Agreement or by ADTRAN, shall VOID AND NULLIFY, in its entirety, all warranty conditions as set forth in Warranty paragraph.

ENGINEERING CHANGES: ADTRAN reserves the right to make progress and design changes in standard product items ordered without prior approval or notification to Buyer and without incurring any obligations or liability to make the same changes in items previously manufactured.

DATA RIGHTS: Rights to any intellectual property residing in the products or any data furnished hereunder are not granted except by specific written permission by an authorized representative of ADTRAN. Buyer shall have no right to copy or reproduce in whole or part any data furnished hereunder without the prior written consent of ADTRAN.

PATENT AND COPYRIGHT INDEMNITY: ADTRAN warrants that the equipment and documentation furnished under this Agreement shall be free and clear of infringement of any patent or copyright covering the structure or composition of such articles or documentation. In the event of a claim, suit, or action against Buyer alleging such infringement, ADTRAN shall save Buyer and its affiliates, agents or customers harmless from liability as finally determined by a court of competent jurisdiction, for such infringement, provided that Buyer gives ADTRAN notice promptly of such claim, suit, or action, and shall have given ADTRAN full and exclusive control of the defense thereof, and that ADTRAN shall have sole right to settle or compromise such claim, suit, or action.

In the event of a claim, suit or action against ADTRAN alleging infringement by the use of any such equipment or documentation, furnished under this Agreement, in combination with other articles or in carrying out any process covered by a patent owned or controlled by any other person, in which independent use of the equipment under this Agreement would not be an infringement. Buyer shall save ADTRAN harmless from liability, as finally determined by a court of competent jurisdiction, for such infringement, provided that ADTRAN shall have given Buyer full and exclusive control of the defense thereof, and that Buyer shall have the sole right to settle claim, suit or action.

Except as herein provided in this indemnity paragraph, neither Buyer nor ADTRAN makes any warranty to the other with respect to any claim, suit or action of any third party by way of infringement and neither party shall be responsible to the other for any loss, cost or damages consequential or otherwise, that may be suffered by the other as a result of any such claim, suit or action.

Telephone Company Contacts for ISDN Service

Ameritech ISDN Repair	1-800-TEAMDATA
Bell Atlantic South	1-800-570-ISDN
Bell South	1-800-247-2020
Cincinnati Bell	1-513-241-6900
Bell Atlantic North	1-800-GET-ISDN 1-800-430-ISDN (New England Area)
Pac Bell	1-800-4PB-ISDN
Rochester Tel	1-716-777-1811 (Repair) 1-716-777-2000 (Order)
Southwestern Bell	1-800-792-4736
US West	1-800-223-7508 (Repair) 1-800-244-1111 (Order)

Affidavit Requirements for Connection to Digital Services

- An affidavit is required to be given to the telephone company whenever digital terminal equipment without encoded analog content and billing protection is used to transmit digital signals containing encoded analog content which are intended for eventual conversion into voiceband analog signals and transmitted on the network.
- The affidavit shall affirm that either no encoded analog content or billing information is being transmitted or that the output of the device meets Part 68 encoded analog content or billing protection specifications.
- End user/customer will be responsible to file an affidavit with the local exchange carrier when connecting unprotected Customer Premises Equipment (CPE) to 1.544 Mbps or subrate digital services.
- Until such time as subrate digital terminal equipment is registered for voice applications, the affidavit requirement for subrate services is waived.

Affidavit for Connection of Customer Premises Equipment to 1.544 Mbps and/or Subrate Digital Services

For the work to be performed in the certified territory of

_____ (telco name)

State of _____

County of _____

I, _____ (name),

_____ (business address),

_____ (telephone number)

being duly sworn, state:

I have responsibility for the operation and maintenance of the terminal equipment to be connected to 1.544 Mbps and/or _____ subrate digital services. The terminal equipment to be connected complies with Part 68 of the FCC rules except for the encoded analog content and billing protection specifications. With respect to encoded analog content and billing protection:

() I attest that all operations associated with the establishment, maintenance, and adjustment of the digital CPE with respect to analog content and encoded billing protection information continuously complies with Part 68 of the FCC Rules and Regulations.

() The digital CPE does not transmit digital signals containing encoded analog content or billing information which is intended to be decoded within the telecommunications network.

() The encoded analog content and billing protection is factory set and is not under the control of the customer.

I attest that the operator(s)/maintainer(s) of the digital CPE responsible for the establishment, maintenance, and adjustment of the encoded analog content and billing information has (have) been trained to perform these functions by successfully having completed one of the following (check appropriate blocks):

() A. A training course provided by the manufacturer/grantee of the equipment used to encode analog signals; or

() B. A training course provided by the customer or authorized representative, using training materials and instructions provided by the manufacturer/grantee of the equipment used to encode analog signals; or

() C. An independent training course (e.g., trade school or technical institution) recognized by the manufacturer/grantee of the equipment used to encode analog signals; or

() D. In lieu of the preceding training requirements, the operator(s)/maintainer(s) is (are) under the control of a supervisor trained in accordance with _____ (circle one) above.

I agree to provide _____ (telco's name) with proper documentation to demonstrate compliance with the information as provided in the preceding paragraph, if so requested.

_____ Signature

_____ Title

_____ Date

Transcribed and sworn to before me

This _____ day of _____, _____

Notary Public

My commission expires:

Table of Contents

List of Figures	xix
List of Tables	xxi
Chapter 1 Overview	1-1
AO/DI	1-1
Express Configuration Software	1-1
Analog Devices Supported	1-2
Remote Access	1-2
Express 3000 Features	1-2
System Requirements	1-3
Ordering a Basic Rate ISDN Line	1-4
Express 3000 Shipping Contents	1-4
Additional Documentation	1-4
Chapter 2 Setting Up the Express 3000	2-1
Windows Installation Procedure	2-2
Connecting the Hardware: Windows	2-2
Installing the Express 3000: Windows 95/98	2-3
Installing the Express Configuration Software: Windows	2-4
Installing the Express 3000: Windows NT	2-4
Macintosh Installation Procedure	2-5
Connecting the Hardware: Macintosh	2-6
Installing the Express Configuration Software: Macintosh	2-7
Express 3000 Physical Description	2-7
Front Panel	2-7
Rear Panel	2-8
Setting the DIP Switches	2-9
DIP Switch 1	2-9
DIP Switch 2	2-9
Using Supplemental Analog Devices	2-10
Connecting Supplemental Devices	2-10
Connecting Your Primary Telephone	2-11

Shared Port for Analog Devices	2-11
Chapter 3 Using the Express Configuration Program	3-1
Before Using the Program	3-2
Opening the Program	3-2
Instructions for Windows 95, 98, and NT	3-2
Closing The Program	3-3
Launching the Tray Tool	3-3
Instructions for Macintosh	3-3
Opening the Tray Tool Menu	3-4
Properties	3-4
Toll Saver	3-4
Refresh	3-4
Enable/Disable Modem	3-4
Capture COM Port	3-4
About Express Configuration	3-4
Help on Express Configuration	3-4
Exit	3-4
Factory Default settings	3-5
Restoring Factory Default Settings	3-5
Using On-line Help	3-5
Understanding Profiles	3-6
ISDN Profiles	3-6
User Profiles	3-6
Internet Access Protocols	3-6
Remote Access Protocols	3-7
Using Profiles	3-7
ISDN Profile Window	3-7
General Tab	3-8
Switch Type	3-8
Area Code	3-8
Phone Numbers 1and 2	3-9
SPIDs 1and 2	3-9
Disable SPID download	3-9
NI1 Conference Feature	3-9
NI1 Transfer Feature	3-10
NI1 Message Feature	3-10
Packet Tab	3-10

TX Window Size	3-10
RX Window Size	3-10
Packet Size	3-10
Packet DN	3-10
Packet TEI	3-10
Dial Prefix	3-10
Preview Tab	3-11
User Profile Window	3-11
General Tab	3-12
Protocol	3-12
PPP Mode	3-12
Enable Bandwidth on Demand	3-12
Disable BACP	3-12
DTR Options	3-12
Flow Control	3-13
Data Call Type	3-13
Data Over Voice	3-14
Call Routing	3-14
Enable Distinctive Ringing	3-14
Protocols Tab	3-14
Enable AO/DI	3-14
Raise Threshold	3-14
Lower Threshold	3-15
Add Time	3-15
Drop Time	3-15
Available Channels	3-15
Type	3-15
TXINIT	3-15
TXFA	3-15
TXADD01	3-16
TXDEQ	3-16
TANULL	3-16
TCID	3-16
Phone List Tab	3-16
Allow only stored numbers	3-16
Stored Numbers	3-16
Enable Call Rejection List	3-16
Enable Anonymous Call Rejection	3-17
Incoming Voice Call Rejection List	3-17

Advanced Tab	3-17
V120 Lower Layer Compatibility	3-17
Connect Timeout	3-17
Inactivity Timer	3-17
Remote Password	3-17
Test Timeout	3-18
Auto Answer	3-18
Disable call waiting on POTS 1 and 2	3-18
Flash/Hook Default	3-18
Preview Tab	3-18
Creating New Profiles	3-19
Saving Profiles	3-19
Modifying Profiles	3-20
Copying Profiles	3-20
Deleting Profiles	3-21
Importing Profiles	3-22
Exporting Profiles	3-22
Reading Configuration Information into the Current Profile	3-23
Using Diagnostics	3-23
Diagnosing Local Units	3-24
Displaying the Unit's Current Status	3-24
Displaying the Express 3000's Caller ID Log Buffer	3-24
Retrieving Current Settings	3-24
Diagnosing Connection Problems	3-25
Launching Terminal Programs	3-25
Diagnosing Remote Units	3-25
Testing a Remote Unit	3-25
Configuring a User Profile on a Remote Unit	3-25
Retrieving Current Settings from a Remote Unit	3-25
Retrieving Status Buffer Information from a Remote Unit	3-26
Customizing the ADTRAN Express Configuration program ..	3-26
Detecting the Connection	3-26
Automatically Detecting the Unit on Startup	3-27
Using Caller ID	3-27
Using Terminal Software for Diagnostics	3-27
Using the Wizard	3-28
Automatically Running the Wizard on Startup	3-30
Locating Information About the Program	3-30

Chapter 4 Using VT-100 Terminal Emulation	4-1
Accessing Terminal Menus	4-2
Exiting the Terminal Menus	4-3
Placing the Unit Back On-line	4-3
Displaying the Status Buffer	4-3
Status Buffer Messages	4-4
Chapter 5 Optional Calling Features	5-1
Call Conferencing	5-1
Call Forwarding	5-2
Caller ID	5-2
Call Return	5-2
Call Reject	5-2
Call Rejection List	5-2
Anonymous Call Rejection	5-2
Call Waiting	5-3
Controlling Call Waiting	5-3
Message Waiting Indicator	5-4
POTS Ports Distinctive Rings	5-4
Chapter 6 Upgrading Software	6-1
Upgrading Files Using the Express Configuration Program ...	6-1
Upgrading Software Using HyperTerminal	6-3
Chapter 7 Installing an Analog Modem	7-1
External Analog Modem Application	7-1
Connecting an External Analog Modem	7-3
Configuring the External Analog Modem	7-4
Setting the Carrier Detect Signal	7-4
Controlling an External Analog Modem	7-5
Controlling the Modem via Terminal Emulation	7-5
Internal Analog Modem Application	7-6
Connecting an Internal Analog Modem	7-7
Chapter 8 Troubleshooting	8-1
Troubleshooting Guidelines	8-1

Appendix A AT Commands and S-RegistersA-1

Appendix B Status Buffer MessagesB-1

Appendix C Loop Status MessagesC-1

Appendix D Connector Pinouts D-1

Appendix E Acronyms and Abbreviations E-1

Appendix F Glossary F-1

IndexIndex-1

List of Figures

Figure 1-1. Express 3000 Contents	1-5
Figure 2-1. Front Panel LEDs	2-7
Figure 2-2. Express 3000 Rear Panel	2-8
Figure 2-3. DIP Switch Locations on Rear Panel	2-9
Figure 2-4. Possible Hardware Configuration	2-10
Figure 2-5. POTS Interfaces.	2-11
Figure 3-1. ADTRAN Express Configuration GUI	3-2
Figure 3-2. Tray Tool Icon in the Taskbar	3-3
Figure 3-3. ISDN Profile Setup Window	3-8
Figure 3-4. User Profile Setup Window	3-11
Figure 3-5. Diagnostics Window	3-24
Figure 3-6. Preferences Window	3-26
Figure 3-7. ADTRAN Express Configuration Wizard	3-28
Figure 3-8. Window for Entering ISDN Phone Numbers	3-29
Figure 3-9. Window for Entering SPID Numbers	3-29
Figure 4-1. VT 100 Terminal Configuration Menu	4-2
Figure 4-2. VT 100 Terminal Status Buffer Menu	4-3
Figure 7-1. External Analog Modem Application	7-2
Figure 7-2. Internal Analog Modem Connections	7-7
Figure D-1. EIA-232 Interface	D-1
Figure D-2. Modem Interface	D-2
Figure D-3. RJ-11 POTS Port Interface	D-3
Figure D-4. RJ-45 ISDN Line Interface	D-3
Figure D-5. Express 3000 Power Supply	D-3

List of Tables

Table 1-1. Customer-provided Requirements 1-3
Table 2-1. Express 3000 LED Descriptions 2-8
Table 3-1. ADTRAN Express Configuration Program Options. 3-1
Table 4-1. Menu Hot Keys. 4-2
Table D-1. EIA-232 Interface Pinout D-1
Table D-2. Modem Interface Pinout D-2

Chapter 1 Overview

The ADTRAN Express 3000™ is a stand-alone ISDN modem that is ideal for remote access and Internet connectivity. The Express 3000 transmits data at speeds up to 230.4 kbps when using hi/fn compression and up to 512 kbps when using Microsoft compression. The Express 3000 includes ISDN terminal adapter and network termination functionality, eliminating the need for an external NT-1 device. The unique modem port on the rear of the Express 3000 allows an analog modem and the Express 3000 to operate from the same computer serial port on a PC or Macintosh.

AO/DI

The Express 3000's Always On/Dynamic ISDN (AO/DI) technology allows a virtual connection to a corporate network or to the Internet while conserving costs. AO/DI allows data transmission over the low bandwidth D channel using the X.25 packet network. As demand for greater bandwidth is presented to the Express 3000, B channels are added to accommodate the increased data flow. As demand for bandwidth decreases, B channels are automatically disconnected to conserve bandwidth and the cost associated with using a B channel. To use this service, your Internet Service Provider (ISP) or remote access provider must support AO/DI.

EXPRESS CONFIGURATION SOFTWARE

ADTRAN's Express Configuration software, included with the Express 3000, makes connecting to ISDN and configuring the Express 3000 easy. This software includes on-line help to assist you in quickly and easily setting up your system (see also *Using On-line Help* on page 3-5). Expert ISDN, part of the Express Configuration software, contains sophisticated patented algorithms that automatically detect the telephone company parameters such as Switch Type and

Service Profile Identifier (SPID) numbers. In areas where the telephone company supports SPID download, this information automatically downloads to the modem, and the Express 3000 becomes plug-and-play with the ISDN line.

ANALOG DEVICES SUPPORTED

The Express 3000 supports up to two analog devices such as telephone, FAX machine, or analog modem in addition to the computer connection for data transmissions. When transmitting data at maximum throughput over both B channels using Multilink PPP, the Express 3000 modem automatically detects calls on the analog ports. Upon detection, the Express 3000 modem adjusts the speed of the data call to 64 kbps using one B channel and accepts the analog/voice call on the other B channel. After completing the analog/voice call, the Express 3000 modem automatically resumes data transfer over both B channels.

REMOTE ACCESS

Remote access gives Management Information Systems (MIS) managers the flexibility of adjusting the configuration of remote units over the ISDN line.

EXPRESS 3000 FEATURES

The Express 3000 provides the following features:

- Data rates up to 230.4 kbps—more than six times faster than a V.34 analog modem
- Simple setup with the ADTRAN Express Configuration Software™
- Automatic SPID and Switch Type detection using ADTRAN Expert ISDN (covered under patent number 5,715,241), or Auto SPID download, where available
- LZS® technology from hi/fn™ for up to 4 to 1 compression
- Support for Always On Dynamic ISDN (AO/DI) technology

- Remote configuration
- Windows® Plug and Play compatibility
- Connections for two analog devices
- External analog modem support—no additional COM port required (patent number 5,708,663)
- Custom calling features such as Caller ID and Call Waiting

SYSTEM REQUIREMENTS

Table 1-1 shows *customer-provided* requirements for using the Express 3000.

Table 1-1. Customer-provided Requirements

Requirement	PC	Macintosh
Computer	386 or higher	Power Mac or 68020 processor
Operating system	Windows 95/98 Windows NT 4.0 or greater	7.0 or greater
Compact-disk drive	Required	Required
Free disk space	1.5 MB	2 MB
Modem cable	Serial	High speed
16550 UART high-speed serial port	Required for data speed of 230.4 kbps.	
EIA-232 serial cable	Connector on one end is DB-25, the connector on other end matches the COM port on your computer.	
One Basic Rate ISDN Line	Includes two ISDN phone numbers; sometimes referred to as local directory numbers (see also <i>Ordering a Basic Rate ISDN Line</i> on page 1-4).	
 NOTE	<i>Single-ISDN phone number and point-to-point lines are not recommended for use with the Express 3000.</i>	

ORDERING A BASIC RATE ISDN LINE

Request EZ-ISDN 1 (Capability Package U) when ordering your ISDN line from the telephone company. The telecommunications industry recommends EZ-ISDN 1 for most home office/small business applications. If EZ-ISDN is not available from your service provider, order Generic Data S. AO/DI requires X.25 packet service; request a dedicated packet number and a fixed Terminal Endpoint Identifier (TEI) of 0x21.

For more information on ordering your ISDN line, see the ADTRAN document *Ordering ISDN Service User Guide*, part number 60000.015-8, available on the ADTRAN home page at <http://www.adtran.com> or by calling ADTRAN (see inside back cover). You can also contact the telephone company for alternative line configurations.

EXPRESS 3000 SHIPPING CONTENTS

The Express 3000 is packaged with the following contents (see also Figure 1-1 on page 1-5).

- RJ-45 to RJ-11 ISDN cable
- AC power supply
- Express 3000
- Quick Start Guide
- CD-ROM (*Contains Express 3000 User Manual and ADTRAN Express Configuration software for Windows 95/98, Windows NT, and Macintosh.*)



Due to the number of differing COM ports, customers must provide the serial cable that connects the Express 3000 to their computer (see also Table 1-1 on page 1-3).

ADDITIONAL DOCUMENTATION

See the ADTRAN web site (<http://www.adtran.com>) for additional technical notes, documents, and scripts. This documentation provides

information on how to use ADTRAN products in specific applications on PC and Macintosh platforms.

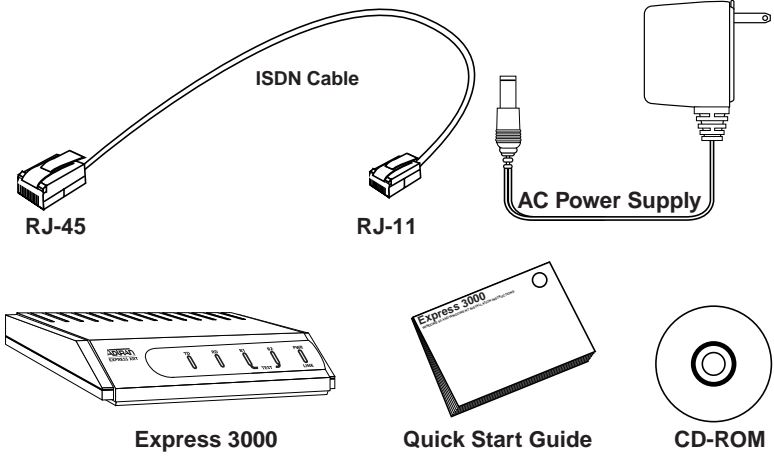

Figure 1-1. Express 3000 Contents

Chapter 2 Setting Up the Express 3000

This chapter tells you how to connect the Express 3000 to a computer, how to install the Express 3000 into your system, and how to install the Express Configuration software. For most instances, once you have completed these three steps, the Express 3000 is ready to use. (However, if you want to reconfigure your unit, see Chapter 3, Chapter 4, or Appendix A.) This chapter also provides a physical description of the Express 3000 and discusses using and connecting supplemental analog devices.

For specific operating system installation procedures, see the following sections:

Windows

- *Connecting the Hardware: Windows* on page 2-2
- *Installing the Express 3000: Windows 95/98* on page 2-3
- *Installing the Express Configuration Software: Windows* on page 2-4
- *Installing the Express 3000: Windows NT* on page 2-4

Macintosh

- *Connecting the Hardware: Macintosh* on page 2-6
- *Installing the Express Configuration Software: Macintosh* on page 2-7.

WINDOWS INSTALLATION PROCEDURE

The following Step/Action tables provide step-by-step instructions for installing the Express 3000. However, the basic installation procedure is as follows:

1. Connect and power up the hardware (see page 2-2).
2. Install the Express 3000 into the operating system (see page 2-3).
3. Install the Express Configuration software (see page 2-4).

Connecting the Hardware: Windows

As the first step in getting your Express 3000 up and running, install the hardware. To ensure success, closely follow the instructions below—particularly those relating to installing the cables.

Windows Instructions for Connecting the Hardware	
Step	Action
1	<p>Connect the Express 3000 to the PC:</p> <p>With the computer's power off and using an appropriate serial cable (this serial cable is not provided—see Table 1-1 on page 1-3), connect the EIA-232 port on the Express 3000 to an available COM port on the computer.</p>
2	<p>Power on the Express 3000:</p> <p>Plug the Express 3000 power supply cord into the port on the unit labeled <i>PWR</i>. Plug the other end into an electrical outlet. The Express 3000 is now powered on.</p>
3	<p>Connect the Express 3000 to the ISDN line:</p> <p>Plug the large (RJ-45) end of the provided ISDN cable into the jack on the rear of the Express 3000 labeled <i>ISDN</i>; plug the small (RJ-11) end of the same ISDN cable into the ISDN telephone wall jack.</p>
4	<p>Power on the computer.</p>
5	<p>Insert the provided Express 3000 CD-ROM into the CD-ROM drive.</p>

Installing the Express 3000: Windows 95/98

Before you can use the Express 3000, your PC must recognize the unit and communicate with it (i.e., the unit must be “installed” into the system). Windows 95/98 systems automatically detect the presence of new hardware and search for the driver that allows this communication. When the driver is located, Windows installs it and the unit is ready to use. (The Express 3000 CD that came with your unit contains the appropriate driver that allows the Express 3000 and your PC to communicate.) Follow the instructions in the Step/Action table below to install the unit.

Windows 95/98 Express 3000 Installation Procedure	
Step	Action
1	If you haven't already done so, insert the Express 3000 CD into the CD-ROM drive. <i>(The Express 3000 CD launches automatically, and the Windows 95/98 operating systems detect and install the necessary driver for installing the Express 3000 into the system.)</i>
 NOTE	<i>Alternatively, you can launch the CD by double-clicking on the My Computer icon and then on the icon for the drive labelled Express 3000.</i>
2	When the ADTRAN Installation Helper runs, go to the instructions <i>Installing the Express Configuration Software: Windows</i> on page 2-4.

Installing the Express Configuration Software: Windows

The Express Configuration software helps you configure your unit. Follow the instructions in this Step/Action table to install this software.



*During software installation, if you encounter any error screens or if the unit remains at **Link Down** (i.e., blinking green LEDs) for longer than 15 minutes, see *Troubleshooting on page 8-1*.*

Installing the Express Configuration Software: Windows

Step	Action
1	If you haven't already done so, insert the Express 3000 CD into the CD-ROM drive.
2	Click on Install .
3	Follow the on-screen instructions to complete the installation.

Installing the Express 3000: Windows NT

The Windows NT operating system does not automatically detect and install the necessary driver for installing the Express 3000; therefore, you must follow the procedure outlined here.

Windows NT Express 3000 Installation Procedure

Step	Action
1	Double-click in turn, each of the following icons: My Computer > Control Panel > Modems.
2	Click the Add button to display the Install New Modem window.
3	Click the Next button. (<i>Windows NT detects the Express 3000.</i>)

Windows NT Express 3000 Installation Procedure	
Step	Action
4	To complete the installation, follow the on-screen instructions.
5	Double-click on the icon, My Computer .
6	Double-click on the icon for the drive labelled Express 3000.
7	The ADTRAN Installation Helper automatically runs. Follow the instructions in <i>Installing the Express Configuration Software: Windows</i> on page 2-4.



If you are asked for a driver disk provided by the hardware manufacturer, enter the letter of the CD-ROM drive containing the Express 3000 CD.

MACINTOSH INSTALLATION PROCEDURE

The following Step/Action tables provide step-by-step directions for installing the Express 3000 on a Macintosh; however, the basic installation procedure is as follows:

1. Connect and power up the hardware (see page 2-6).
2. Install the Express Configuration software (see page 2-7).

Connecting the Hardware: Macintosh

Macintosh Instructions for Connecting the Hardware	
Step	Action
1	<p>Connect the Express 3000 to the Macintosh:</p> <p>With the Macintosh's power off and using a Macintosh high-speed modem cable (not provided), connect the EIA-232 port on the Express 3000 to an available communications port on the Macintosh.</p> <p> NOTE <i>Macintosh high-speed modem cables are available at any electronics store that carries Macintosh equipment.</i></p>
2	<p>Power on the Express 3000:</p> <p>Plug the Express 3000 AC power cord into the port on the unit labeled <i>PWR</i>. Plug the other end into a 120 V electrical outlet. The Express 3000 is now powered on.</p>
3	<p>Connect the Express 3000 to the ISDN line:</p> <p>Plug the RJ-45 connector (large end) of the provided ISDN cable into the jack on the rear of the Express 3000 labeled <i>ISDN</i>; plug the RJ-11 connector (small end) of the same ISDN cable into the ISDN telephone wall jack.</p>
4	<p>Power on the Macintosh.</p>

Installing the Express Configuration Software: Macintosh

Installing the Express Configuration Software: Macintosh	
Step	Action
1	Insert the provided Express 3000 CD into the CD-ROM drive.
2	With QuickTime enabled, the ADTRAN Installation Helper automatically runs. Follow the on-screen instructions.

EXPRESS 3000 PHYSICAL DESCRIPTION

This section describes the Front and Rear Panels of the Express 3000.

Front Panel

The Express 3000 Front Panel contains five LEDs associated with the DTE port and the ISDN interface (see Figure 2-1). Table 2-1 describes the LEDs.

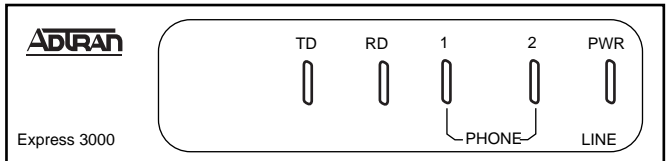

Figure 2-1. Front Panel LEDs

Table 2-1. Express 3000 LED Descriptions

LED	Color	Description
TD	Green	Transmit Data (TxD).
RD	Green	Received Data (RxD).
1 or 2	Slow Green Flash	Attempting SPID registration.
	Fast Green Flash	Attempting TEI registration.
	Solid Green	POTS 1 or 2 in use.
	Off	Ready. No data traffic.
	Solid Amber	B channel 1 or 2 passing data.
	Amber Flash	Remote test originate.
PWR/LINE	Solid Green	Link established. Calls can be placed.
	Off	No power.
	Flashing	Link is not established. Calls cannot be placed.

Rear Panel

The Express 3000 Rear Panel contains all of the interfaces used in connecting your unit and two DIP switches that set the DTE rate and reset your unit (see Figure 2-2). Please read carefully the section *Setting the DIP Switches* on page 2-9. Appendix D describes the pinouts for these interfaces.

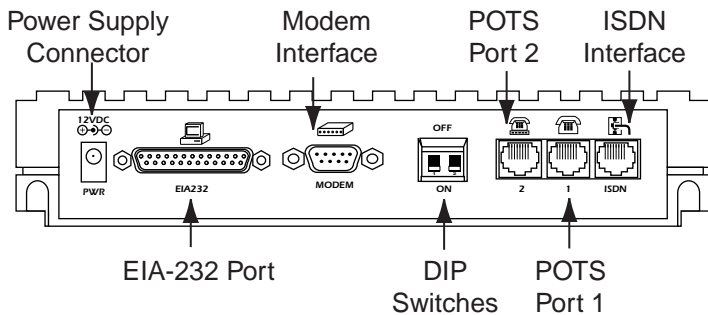
**Figure 2-2. Express 3000 Rear Panel**

Setting the DIP Switches

The Express 3000 contains two DIP switches (1 and 2), located on the Rear Panel. These switches let you physically configure DTE rates and reset the unit. The factory default position for both switches is **down (ON)**. Leave the switches in the **down (ON)** position during the initial installation. Figure 2-3 shows the location of the switches on the Rear Panel.

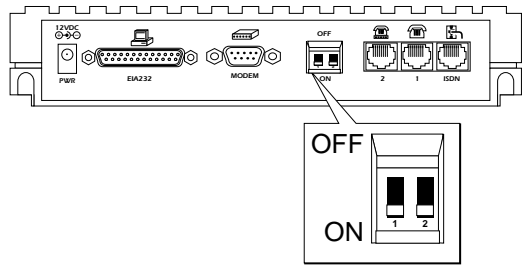

Figure 2-3. DIP Switch Locations on Rear Panel

DIP Switch 1

With DIP switch 1 set to the **ON (down)** position, the Express 3000 automatically adapts to the DTE rate, up to 115.2 kbps. With DIP switch 1 set to the **OFF (up)** position, the unit operates at a DTE rate of 230.4 kbps. A special serial COM port using a 16650 UART chip is required to operate at this higher rate.

DIP Switch 1: (DTE Rates)	On (Down) = Autobaud (speeds up to 115.2 kbps)
	Off (Up) = 230.4 kbps (requires 16650 UART)

DIP Switch 2

DIP switch 2 resets factory default settings when you set it to the **OFF (up)** position. When the switch is set to the **ON (down)** position, new settings can be entered. These settings are saved until DIP switch 2 is reset to the **OFF (up)** position; then, they are cleared.

DIP Switch 2: (Reset)	Off (Up) = Factory Default (resets settings)
	On (Down) = Normal (saves settings)

USING SUPPLEMENTAL ANALOG DEVICES

With the Express 3000 you can use two analog devices such as a telephone, FAX machine, analog modem (external or internal), answering machine, or Caller ID box. (For detailed information on installing an analog modem, see Chapter 7.) Figure 2-4 depicts one possible hardware configuration.

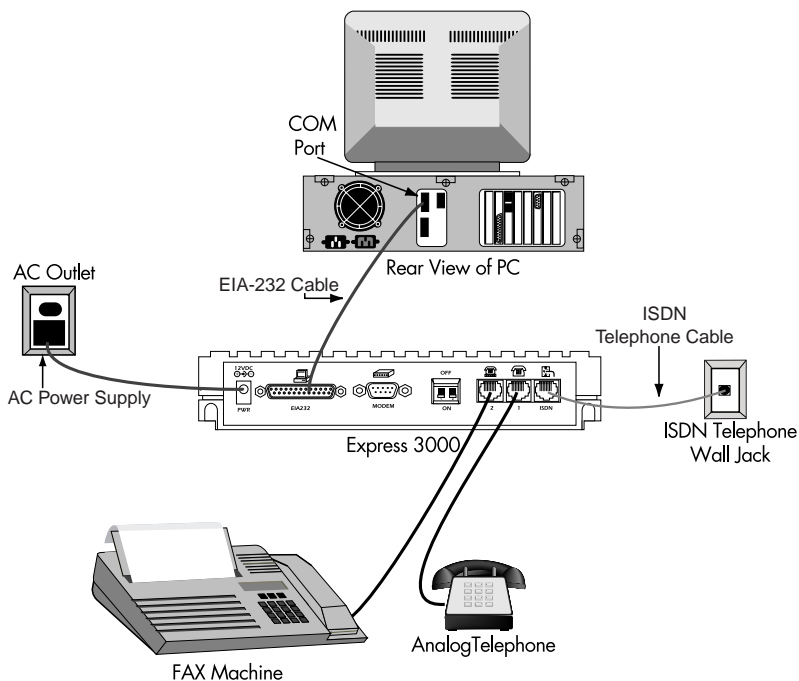

Figure 2-4. Possible Hardware Configuration

CONNECTING SUPPLEMENTAL DEVICES

Connect the supplemental devices to the two Plain Old Telephone Service (POTS) interfaces (jacks) on the Express 3000 Rear Panel. These RJ-11 jacks are labeled 1 and 2. In addition, an illustration of a telephone identifies jack 1, and an illustration of a telephone resting on a modem identifies jack 2 (see Figure 2-5).

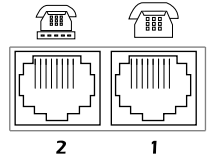

Figure 2-5. POTS Interfaces

Connecting Your Primary Telephone

The Basic Rate ISDN line, required for using the Express 3000, includes two ISDN phone numbers (see also, *Ordering a Basic Rate ISDN Line* on page 1-4). The Express 3000 allocates ISDN phone number 1 to POTS port 1. Connect your primary telephone (the one you use to talk to people) to POTS port 1 (see Figure 2-5).

Shared Port for Analog Devices

ISDN phone number 2 is shared by the EIA-232 port and the POTS port 2; therefore, you cannot use both ports at the same time. For example, you can't use a FAX machine connected to POTS port 2 at the same time you are using the Express 3000 for, say, Internet access.



ISDN data calls and external modem applications must be placed to ISDN phone number 2, so provide this number as your FAX number, etc.

Chapter 3 Using the Express Configuration Program

The Express 3000 comes from the factory preconfigured and ready to use. You can, however, use the ADTRAN Express Configuration Software to change and restore these settings. The program also contains other functions (see Table 3-1).

Table 3-1. ADTRAN Express Configuration Program Options

Option	Function
isdn setup	Configures an ISDN profile.
profile setup	Configures a User profile.
diagnostics	Provides detailed information about the status of the Express 3000 while it is off-line. You can also upgrade the unit firmware from here.
preferences	Allows you to turn on or off automatic user configuration features such as Caller ID.
wizard	Guides you through the configuration process.
about	Displays version and registration information.
help	Provides on-line help.
exit	Closes the software and, depending on the preferences settings, opens the Tray Tool.



You can also configure the Express 3000 via VT-100 terminal emulation (see Chapter 4) and using the AT Commands (see Appendix A).

The ADTRAN Express Configuration program provides a graphical user interface (GUI) that lets you configure your unit, run diagnostic tests, display and specify connection settings, apply certain preferences, run the Express Configuration Wizard, view the software version

number, open the on-line help file, and close the GUI window. The left panel of the GUI lists these options (see Figure 3-1 on page 3-2).

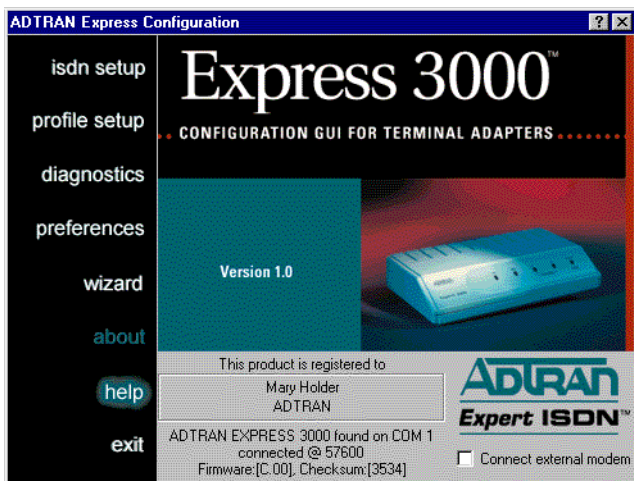

Figure 3-1. ADTRAN Express Configuration GUI

BEFORE USING THE PROGRAM

Before opening the Express Configuration program, ensure that the Express 3000 is properly connected to your computer and that it is powered on. Also, exit any applications that may be using the Express 3000.

OPENING THE PROGRAM

Open the Express Configuration program in the manner appropriate to your system. Once the program opens, you can begin using it immediately.

Instructions for Windows 95, 98, and NT

Click the following sequence: **Start > Programs > Adtran > ADTRAN Express Configuration Wizard.**

Instructions for Macintosh

Open the **ADTRAN ISDN** folder, and double-click the **Express Configuration** icon.

CLOSING THE PROGRAM

Close the Express Configuration program by clicking **Exit** on the left panel of the ADTRAN Express Configuration window or by clicking the close button (☒) on the Title Bar.



*If **Add Tray Tool** (under preferences) is selected, the Express icon (Tray Tool) appears in the Task Bar when you close the program (for more information on the Tray Tool, see *Launching the Tray Tool* on page 3-3).*

LAUNCHING THE TRAY TOOL

With the **Preferences** menu item **Add Tray Tool** selected, the Tray Tool launches when you close the Express Configuration program. The Tray Tool provides quick access to the Express Configuration program and other features. You can tell that the Tray Tool is active because the Tray Tool icon resides in the Windows Task Bar (see Figure 3-2). To close the Tray Tool, right-click on the Tray Tool icon and select **Exit**.



Figure 3-2. Tray Tool Icon in the Taskbar

Opening the Tray Tool Menu

To open the **Tray Tool Menu**, click the right-mouse button on the Tray Tool icon located in the Task Bar (see Figure 3-2). A brief description of these menu items follows.

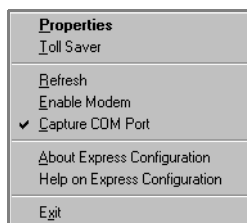

Properties

Launches the Express Configuration program.

Toll Saver

Quickly and easily determines how much you have spent on your ISDN Line. To access Toll Saver, right click the Tray Tool and select Toll Saver.

Refresh

Instructs the Express Configuration Software to update the icon status.

Enable/Disable Modem

Enables or disables the external analog modem. This option is only available when the modem is connected to the Express 3000.

Capture COM Port

Allows Caller ID information to display on the screen when you are not using a terminal application or dial-up networking.



*You must disable **Capture COM Port** before using dial-up networking or other terminal packages.*

About Express Configuration

Displays version information.

Help on Express Configuration

Opens the on-line help file.

Exit

Closes the Tray Tool.

FACTORY DEFAULT SETTINGS

The factory default configuration settings suffice for most applications. However, you can change these settings to create custom configurations using ISDN and User profiles (see *Understanding Profiles* on page 3-6). You can also restore these settings at any time.

Restoring Factory Default Settings

To restore the Express 3000 to the factory default settings, follow the steps below:

Instructions for Restoring Factory Default Settings	
Step	Action
1	Set DIP switch 2 to the OFF (Up) position.
2	Disconnect the Express 3000 from the power source.
3	Reconnect the power source for the Express 3000.
4	When the PWR LED flashes, set DIP switch 2 to the ON (Down) position. (See also <i>Setting the DIP Switches</i> on page 2-9)

USING ON-LINE HELP

The ADTRAN Express Configuration program includes on-line help. You can access this help in two ways:

1. Click on **Help** in the left panel of the ADTRAN Express Configuration window.
OR
2. From any dialog box, click the **What's This?** button (??) in the top, right-hand corner of the dialog box, and then click again over the item in question.

UNDERSTANDING PROFILES

A profile stores and retrieves multiple configurations for the Express 3000. An individual profile contains unique settings appropriate to specific applications. Using the Express Configuration program, profiles can be created, saved, copied, edited, and deleted. In addition, importing and exporting profiles simplifies troubleshooting and setup. The Express Configuration program uses two types of profiles: ISDN profiles and User profiles.

ISDN Profiles

ISDN profiles contain configuration information for the ISDN line such as Local Directory Numbers (LDNs), Service Profile Identifiers (SPIDs), and Switch Type. Using the **isdn profile** option of the Express Configuration program, you can modify, create, and delete ISDN profiles. You can store up to 16 ISDN profiles. (See also *Using Profiles* on page 3-7.)

User Profiles

User profiles contain configuration information for the many features of the Express 3000 such as protocol selection, calling features, and a call rejection phone list. Using the **user profile** option of the Express Configuration program, you can modify, create, and delete user profiles. You can store up to 16 user profiles. (See also *Using Profiles* on page 3-7.)



User profiles have no effect on the ISDN line configuration. ISDN line parameters including SPIDs, LDNs, and Switch Type settings remain the same, regardless of changes or applications made with profiles.

Internet Access Protocols

Most Internet Service Providers (ISPs) supporting ISDN also support PPP protocol. Therefore, if you are connecting to an ISP using one B channel, select the following protocol: **profile setup/General/PPP Mode/PPP**. If arrangements have been made with the ISP to use two B channels, select **profile setup/General/PPP Mode/Multilink PPP**.

The Express 3000 uses Bandwidth Allocation Control Protocol (BACP), if supported by your ISP, to bring up and down the second channel of a multilink call. To disable this feature, select the appropriate checkbox: **profile setup / General / Disable BACP**.

Remote Access Protocols

Check with your systems administrator to determine which remote access protocol to use.

Using Profiles

To use profiles, open the Express Configuration program. Then select either **isdn setup** (ISDN profile) or **profile setup** (User profile). Figure 3-3 on page 3-8 shows the window that opens for an ISDN profile, and Figure 3-4 on page 3-11 shows the window that open for a User profile. These windows contain function buttons and parameter tabs. Step-by-step instructions for using the function buttons begin on page 3-19. Parameter tabs are described below.

ISDN Profile Window

The ISDN profile window contains three tabs: General, Packet, and Preview. The General and Packet tabs contain fields for setting parameters. The Preview tab lists information about the profile shown in the **Name** box.

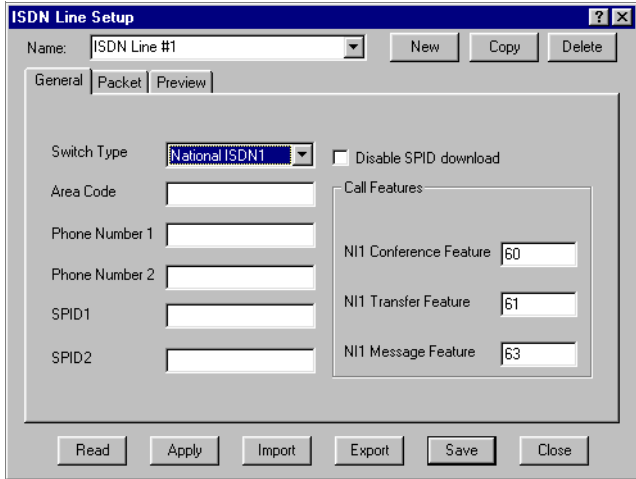

Figure 3-3. ISDN Profile Setup Window

General Tab

The General Tab contains fields for setting ISDN line information such as switch type, area code, phone numbers 1 and 2, and SPIDs 1 and 2. In addition, you can disable the automatic detection of SPIDs. Also, you can enter feature activator codes for conference calling, call transfer, and message waiting.

Switch Type

Defines the switch type for the local version of the software, either AT&T 5ESS, DMS - 100, National ISDN-1, or NEC Switch. If you are running the International version of the Express Configuration Wizard, five additional switch types are available: Euro ISDN, VN4, NTT, KDD, or TDX. (The telephone company should provide this information as part of the ISDN Line installation; if this information is not provided, contact the telephone company.)

Area Code

Sets the area code for the ISDN lines. The area code is the same for both B channels. Enter the area code only if you plan to use the AutoSPID algorithm to automatically detect the Switch Type and SPIDs.

In regions in which the area code has recently changed, the ISDN line may be configured with a new area code. ADTRAN's AutoSPID algorithm attempts to recognize these regions and adjust the area code automatically if AutoSPID initially fails. A table of old area codes and the corresponding new area codes is located in the installation directory. This is a standard text file and may be modified. For Windows 95 and Windows NT 4.0, the default installation directory is C:\Program Files\Adtran\Isdn.

Phone Numbers 1 and 2

Defines the ISDN LDNs. The LDN is the seven digit telephone number assigned to the ISDN line and is used when placing or receiving calls. A multipoint line may have LDNs that resemble the following:

ISDN Phone Number 1: 5551212

ISDN Phone Number 2: 5551213

SPIDs 1 and 2

Identifies the ISDN terminal equipment to the ISDN switch. SPIDs are assigned by the telephone company when the ISDN line is installed. The SPID usually looks similar to the telephone number. For example, a multipoint line may have SPIDs that look as follows:

Service Profile ID 1: 0155512120

Service Profile ID 2: 0155512130

The number of SPIDs required (0, 1, or 2) depends on how the ISDN line is configured. For example, a point-to-point line has no SPIDs. Multipoint lines have one or more SPIDs. The Express 3000 uses the presence of one SPID to determine if the line is multipoint. If the line only has one SPID, then the SPID must be entered in the box labeled Service Profile ID 1.

Disable SPID download

Disables the automatic detection of SPIDs.

N11 Conference Feature

Defines the activator code for Call Conference. This code is generally used only with National ISDN and DMS-100 switches. The default value is 60.

NI1 Transfer Feature

Defines the activator code for Call Transfer. This code is generally used only with National ISDN and DMS-100 switches. The default value is 61.

NI1 Message Feature

Defines the activator code for Message Waiting. The default value is 63.

Packet Tab

The Packet Tab lets you set parameters for X.25 packet service, such as window size, packet size, directory number, terminal endpoint identifier, and the dial prefix.

TX Window Size

Defines the number of unacknowledged packets sent before a reply is required. Used with X.25 flow control.

RX Window Size

Defines the number of unacknowledged receive packets that are allowed before additional packets are rejected. Used with X.25 flow control.

Packet Size

Specifies the size of the X.25 packet sent.

Packet DN

Specifies the owner of the X.25 packet. This seven-digit packet phone number is used when placing X.25 calls.

Packet TEI

Specifies the terminal endpoint identifier (TEI) that is negotiated for D channel packet service. Use a value of 255 for dynamic TEI allocation.

Dial Prefix

Defines the prefix required to dial out on a B channel. This information is only necessary when there is a different prefix for D and B channel access.

Preview Tab

The Preview tab window displays a list of the configuration parameters and their values for the current profile. **ATS** refers to the AT commands for that configuration parameter, **Description** refers to the particular configuration parameter, and **Value** lists the corresponding parameter value.

User Profile Window

The User profile window contains five tabs: General, Protocols, Phone List, Advanced, and Preview. The General, Protocols, Phone List, and Advanced tabs contain fields for setting parameters. The Preview tab lists information about the profile shown in the **Name** box.

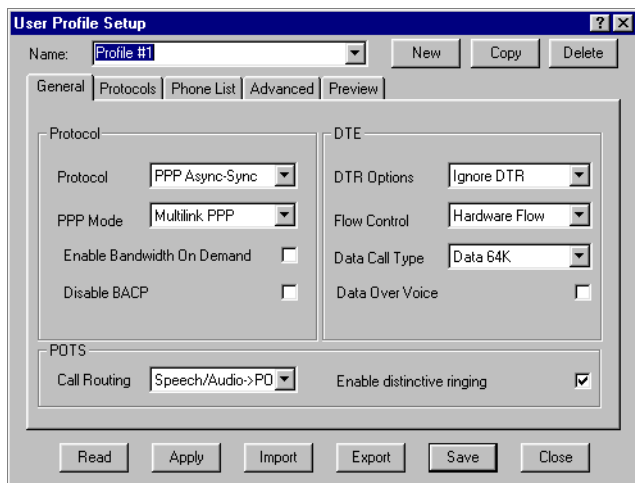

Figure 3-4. User Profile Setup Window

General Tab

The General Tab lets you set Protocol, DTE, and POTS parameters.

Protocol

Sets the protocol type: PPP Async-Sync, Async Bonding, V120, Fallback.

The Express 3000 communicates with many different types of telecommunications equipment including other Express 3000 units, other ISDN terminal adapters, and PPP-compatible devices. Communication between such devices requires various rate adaption protocols supporting various bit rates and RS-232 connector settings (protocol type).

PPP Mode

Selects the PPP mode the Express 3000 uses: Point-to-Point (PPP) Async-to-Sync, Multilink PPP (MP), or PPP with Compression.

Enable Bandwidth on Demand

Uses the thresholds defined in the **Protocols** tab to bring up and down multilink channels, when this feature is enabled.

Disable BACP

Controls the negotiation of Bandwidth Allocation Control Protocol (BACP). BACP allows the client and server to exchange phone number information and bring up and down channels, as needed. Check **Enable Bandwidth on Demand** to use this feature.

DTR Options

Sets the following DTR options:

<i>Ignore DTR</i>	Disregards the state of the data terminal ready (DTR) signal on the EIA-232.
<i>AT Command when Off</i>	Forces the unit into the AT command processor mode when DTR is not asserted. To return on-line, DTR must be asserted and the ATO command must be issued.
<i>Answer if On</i>	Answers incoming calls only if DTR is asserted.
<i>Idle when Off</i>	Forces an end to the current call when DTR is no longer asserted.

Flow Control

Allows communication devices (for example, the Express 3000 and a PC) to deal with one device sending data at a rate higher than the other device.

- | | |
|-------------------|---|
| <i>Hardware</i> | Controls the data transmission between the terminal (PC) and the Express 3000 (via EIA-232 pins). Recommended for high-speed data transmission. |
| <i>Software</i> | Uses characters embedded in the communication software to control the data transmission. The control characters are known as XON/XOFF. Typically used in slower transmission of data. |
| <i>No Control</i> | Disables any type of flow control. |

Data Call Type

Selects the Call Type according to the ISDN line configuration.

- | | |
|--------------------|--|
| <i>Speech</i> | Directs call control software to request a Speech circuit as the bearer capability for outgoing calls. Use with ISDN lines configured for voice service. In some areas voice service is less expensive than data service. A Speech call type does not guarantee an end-to-end digital connection with some local and long distance carriers. |
| <i>Audio</i> | Directs call control software to request a 3.1 kHz Audio circuit as the bearer capability for outgoing calls. Used with an ISDN line configured for voice service. In some areas audio service is less expensive than data service. An Audio call type does not guarantee an end-to-end digital connection with some local and long distance carriers. |
| <i>Data 56kbps</i> | Directs call control software to request a 64 kbps data circuit that is rate-adapted down to 56 kbps. |
| <i>Data 64kbps</i> | Instructs call control software to request an unrestricted 64 kbps data circuit. (Default for the Express 3000.) |

Data Over Voice

Allows data calls to be placed using a Speech Call Type. If a usage charge for data exists in your area, you may benefit from this option.

Call Routing

Specifies how the Express 3000 routes incoming voice calls. Options include the following:

- All Calls to DTE* Routes all calls to the EIA-232 port, regardless of Call Type.
- Speech Calls to POTS* Routes calls with a Speech call type to the POTS ports. Calls with Data 56k, Data 64k, and Audio are routed to the EIA-232 port.
- Speech/Audio Calls to POTS* Routes calls with Speech and Audio call types to the POTS ports. Calls with Data 56k and Data 64k are routed with the EIA-232 port.

Enable Distinctive Ringing

Instructs the Express 3000 to use distinctive rings that are easily recognized on POTS ports 1 and 2.

Protocols Tab

The Protocols Tab provides you with fields for defining the point-to-point protocol (PPP) type. Options include the following:

Enable AO/DI

Configures the unit to operate in AO/DI mode when placing PPP calls. AO/DI allows the unit to place X.25 packet calls over the D channel. This feature requires that X.25 packet service be purchased from your ISDN service provider and AO/DI service be purchased from your Internet Service Provider.

Raise Threshold

Defines the percentage of available bandwidth that must be in use before an additional channel is added. A very high Raise Threshold sends the most packets on the D or, initial, B channel, before adding more B channels. A very low Raise Threshold sends a minimum number of packets on the initial channel. Raise Threshold

works in conjunction with Add Time to increase bandwidth, if it is available.

Lower Threshold

Defines the percentage of available bandwidth that must be in use to maintain bandwidth levels. If the bandwidth in use falls below this level for longer than Drop Time, a channel drops. A very high Drop Threshold increases the number of channels used, which could increase costs.

Add Time

Defines the length of time that bandwidth must remain above Raise Threshold before adding a channel.

Drop Time

Defines the length of time that bandwidth must remain below Lower Threshold before dropping a channel.

Available Channels

Sets the number of available channels to be used in an AO/DI call.

From the Protocols Tab, you can also define the BONDING specifications using the following options:

Type

Defines the type of equipment used in a call. Set to ADTRAN Only when originating BONDING calls to ADTRAN legacy ISU equipment; otherwise, set this field to Multi-Vendor.

TXINIT

Specifies the length of time (in seconds) that the originating unit attempts to detect the Async BONDING negotiating pattern from the answering unit before determining Async BONDING has failed.

TXFA

Specifies the length of time (in seconds) both units attempt to detect the Async BONDING frame pattern when connecting a call before determining Async BONDING has failed.

TXADD01

Specifies the length of time (in seconds) both units wait for an additional call to connect at the end of negotiation before determining Async BONDING has failed.

TXDEQ

Specifies the length of time (in seconds) both units attempt to equalize a network delay between ISDN B channels before determining Async BONDING has failed.

TANULL

Specifies the length of time (in seconds) the answering unit attempts to detect Async BONDING negotiation from the originating unit before determining Async BONDING has failed.

TCID

Specifies the length of time (in seconds) both units attempt to negotiate an agreeable value for B channels and channel capacities before determining Async BONDING has failed.

Phone List Tab

Stores phone numbers used for various call accept or reject criteria.

Allow only stored numbers

Instructs the Express 3000 to accept only incoming calls originating from telephone numbers programmed in Stored Numbers 0 through 9.

Stored Numbers

Accepts and saves ten numbers used for dialing or call screening.

Enable Call Rejection List

Instructs the Express 3000 to compare all incoming Speech and Audio calling party numbers to the list of ten numbers in the Incoming Voice Call Rejection List. If a match between the incoming calling party number and an entry in the Incoming Voice Call Rejection List occurs, the Express 3000 refuses to ring the POTS port. Generally, the caller experiences a busy signal. A message in the Status Buffer is the only indication that a call has been rejected.

Enable Anonymous Call Rejection

Rejects calls where the calling party number is blocked (anonymous). These numbers normally appear as *Private* on a Caller ID unit. With this option selected, the Express 3000 refuses to ring the POTS ports. Generally, the caller experiences a busy signal. A message in the Status Buffer is the only indication that an anonymous call has been rejected.

Incoming Voice Call Rejection List

Contains ten numbers that represent the Call Rejection List. This list is used when the Enable Call Reject List option is checked. When the Express 3000 detects an incoming Voice or Audio call, the telephone number of the caller is compared to the numbers in this list. If a match is found, the call is rejected.

Generally, the format for the number is one seven-digit number. If calls are not being rejected while the option is enabled and a number is programmed, check the Status Buffer for the number of the caller. The number of the caller should match exactly with the number in the Call Rejection List.

Advanced Tab

Contains advanced instructions for the Express 3000.

V120 Lower Layer Compatibility

Sends a low-level compatibility information element as part of the setup message.

Connect Timeout

Sets the length of time that the Express 3000 waits for the far-end unit to answer an outgoing call.

Inactivity Timer

Defines the amount of time (in minutes) the Express 3000 remains idle before automatically disconnecting the current data call. A value of 0 indicates the Inactivity Timer is off.

Remote Password

Accepts the six digit numeric password for the remote unit called. Valid characters are 0 through 9. Alphabetic characters are not accepted.

Test Timeout

Defines the amount of time (in minutes) the Express 3000 tests a remote unit.

Auto Answer

Answers data calls in three different ways:

- Enabled* Automatically answers incoming data calls.
- Disabled* Does not answer data calls. An AT answer command, **ATA**, must be issued before a call can be answered.
- Dump all calls* Keeps the line free for outgoing calls by not answering incoming calls.

Disable call waiting on POTS 1 and 2

Instructs Express 3000 to disable call waiting and give callers either a ringing tone or a busy tone.

Flash/Hook Default

Flash/hook means to press and release the flash button on the telephone keypad. The options include **Call Waiting** and **Conference/Transfer**.

- Call Waiting* Flash/hook used only for call waiting.
- Conference/Transfer* Flash/hook used to connect conference calling parties; however, if incoming call occurs, flash/hook acts as call waiting. (See also, *Call Conferencing* on page 5-1.)

Preview Tab

The Preview Tab window displays a list of the configuration parameters and their value for the current profile. **ATS** refers to the AT commands for that configuration parameter, **Description** refers to the particular configuration parameter, and **Value** lists the corresponding parameter value.

Creating New Profiles

Follow the steps listed below to create a new profile—either ISDN or User.

Instructions for Creating New Profiles	
Step	Action
1	Open the ADTRAN Express Configuration program.
2	On the left panel of the Express Configuration program window, click on either isdn setup (to view the current ISDN profile) or profile setup (to view the current User profile).
3	Click the Setup button to open the setup window.
4	Click on New to create a new profile.
5	Enter a name for the new profile in the Name field.
6	Make any additional changes and click Apply .

Saving Profiles

Follow the steps listed below to save a profile—either ISDN or User.

Instructions for Saving Profiles	
Step	Action
1	Open the ADTRAN Express Configuration program.
2	On the left panel of the Express Configuration program window, click on either isdn setup (to view the current ISDN profile) or profile setup (to view the current User profile).
3	Click the Setup button to open the setup window.
4	From the Name field, select the profile you want to save. (Ensure that the name of the profile you want to save is displayed in the Name field before continuing.)
5	Click the Save button.

Modifying Profiles

Follow the steps listed below to modify profiles—either ISDN or User.

Instructions for Modifying Profiles	
Step	Action
1	Open the ADTRAN Express Configuration program.
2	On the left panel of the Express Configuration program window, click on either isdn setup (to view the current ISDN profile) or profile setup (to view the current User profile).
3	Click the Setup button to open the setup window.
4	From the Name field, select the profile you want to modify. (Ensure that the name of the profile you want to modify is displayed in the Name field before continuing.)
5	Change all of the parameters as necessary (see also <i>Using Profiles</i> on page 3-7).
6	Click the Apply button. (You must <i>apply</i> the changes for them to take effect.)

Copying Profiles

Follow the steps listed below to copy a profile—either ISDN or User.

Instructions for Copying Profiles	
Step	Action
1	Open the ADTRAN Express Configuration program.
2	On the left panel of the Express Configuration program window, click on either isdn setup (to view the current ISDN profile) or profile setup (to view the current User profile).
3	Click the Setup button to open the setup window.

Instructions for Copying Profiles (Continued)	
Step	Action
4	From the Name field, select the profile you want to copy. (Ensure that the name of the profile you want to copy is displayed in the Name field before continuing.)
5	Click the Copy button, and a new profile is created.

Deleting Profiles

Follow the steps below to delete profile—either ISDN or User.

Instructions for Deleting Profiles	
Step	Action
1	Open the ADTRAN Express Configuration program.
2	On the left panel of the Express Configuration program window, click on either isdn setup (to view the current ISDN profile) or profile setup (to view the current User profile).
3	Click the Setup button to open the setup window.
4	From the Name field, select the profile you want to delete. (Ensure that the name of the profile you want to delete is displayed in the Name field before continuing.)
5	Click the Delete button.
6	At the prompt, click the Yes button to delete the profile.

Importing Profiles

Follow the steps below to import profiles—either ISDN or User.

Instructions for Importing Profiles	
Step	Action
1	Open the ADTRAN Express Configuration program.
2	On the left panel of the Express Configuration program window, click on either isdn setup (to view the current ISDN profile) or profile setup (to view the current User profile).
3	Click the Setup button to open the setup window.
4	Click the Import button.
5	In the File Name field, type in the file name to import, or browse and select the file name with the mouse.
6	Click the Open button.

Exporting Profiles

Follow the steps below to export profiles—either ISDN or User.

Instructions for Exporting Profiles	
Step	Action
1	Open the ADTRAN Express Configuration program.
2	On the left panel of the Express Configuration program window, click either isdn setup (to view the current ISDN profile) or profile setup (to view the current User profile).
3	Click the Setup button to open the setup window.
4	Select the name of the profile to export from the Name field. (Ensure that the name of the profile you want to export is displayed in the Name field before continuing.)
5	Click the Export button.

Instructions for Exporting Profiles (Continued)	
Step	Action
6	In the File Name field, type in the file name to export (Windows automatically adds the .ecf extension).
7	Click the Save button.

Reading Configuration Information into the Current Profile

Follow the steps below to read configuration information into the current profile—either ISDN or User.

Instructions for Reading Configuration Information	
Step	Action
1	Open the ADTRAN Express Configuration program.
2	On the left panel of the Express Configuration program window, click on either isdn setup (to view the current ISDN profile) or profile setup (to view the current User profile).
3	Click the Setup button to open the setup window.
4	Select the name of the profile to read from the Name field. (Ensure that the name of the profile you want to read is displayed in the Name field before continuing.)
5	Click the Read button.

USING DIAGNOSTICS

The option, **diagnostics**, provides detailed information about the status of the Express 3000—both local and remote units (see Figure 3-5 on page 3-24).

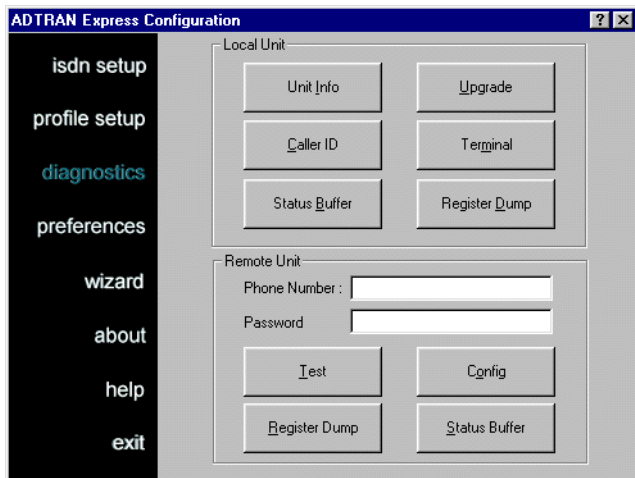

Figure 3-5. Diagnostics Window

Diagnosing Local Units

You can collect information about local units using the **diagnostics** option. Click on the appropriate button to access the information you want.

Displaying the Unit's Current Status

The **Unit Info** button (under **diagnostics**) displays the current status of several items: ISDN Loop Status, Firmware Version, Firmware Checksum, and the status of an external modem.

Displaying the Express 3000's Caller ID Log Buffer

Click the **Caller ID** button (under **diagnostics**) to display the caller's telephone number for incoming Voice and Audio calls while the log is open. To clear the contents of the log buffer, click the **Clear** button.

Retrieving Current Settings

To retrieve the current Express 3000 settings, click the **Register Dump** button (under **diagnostics**). The current settings display in a format identical to the Preview list (see *Preview Tab* on page 3-11 or page 3-18).

Diagnosing Connection Problems

You can diagnose many connection problems by viewing the Status Buffer messages returned from the ISDN network and the ADTRAN Express 3000. Access these messages by clicking the **Status Buffer** button (under **diagnostics**).

Launching Terminal Programs

Launch the terminal program specified in the **preferences** option (**Program Name**) by clicking the **Terminal** button (under **diagnostics**).

Diagnosing Remote Units

With the **diagnostics** option, you can collect information about remote units. Enter the phone number of the remote unit and a password, if required. Then click on the appropriate button to access the information you want. Buttons include **Test**, **Register Dump**, **Config**, and **Status Buffer**.

Testing a Remote Unit

Follow the steps below to begin testing a remote unit.

Instructions for Testing a Remote Unit	
Step	Action
1	Click the Test button (under diagnostics).
2	Choose the number of B channels with which to test.
3	Click Start to begin the remote test.

Configuring a User Profile on a Remote Unit

To configure a User profile on a remote unit, click the **Config** button (under **diagnostics**). (See also *Using Profiles* on page 3-7.)

Retrieving Current Settings from a Remote Unit

To retrieve the current settings from a remote unit, click the **Register Dump** button (under **diagnostics**). The current settings display in a format identical to the Preview list (see *Preview Tab* on page 3-11 or page 3-18).

Retrieving Status Buffer Information from a Remote Unit

To retrieve Status Buffer information from a remote unit, click the **Status Buffer** button (under **diagnostics**). Status Buffer information begins with the most recent call.

CUSTOMIZING THE ADTRAN EXPRESS CONFIGURATION PROGRAM

The **preferences** option on the left panel contains controls that let you modify automatic features (see Figure 3-6).

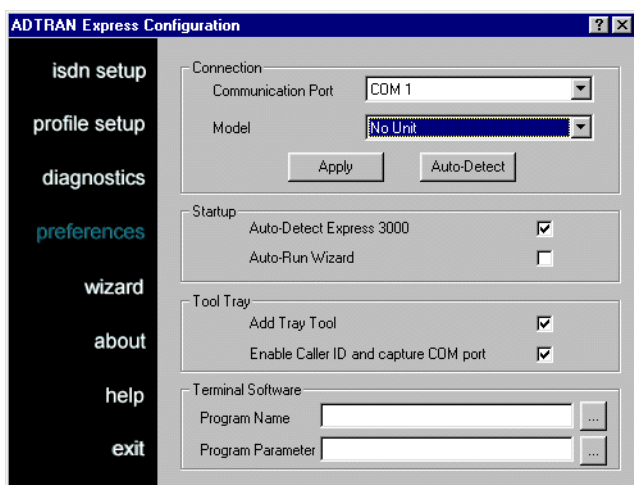

Figure 3-6. Preferences Window

Detecting the Connection

When the **Auto-Detect Express 3000** checkbox is selected (under **preferences**), the Express Configuration program automatically detects the presence of the Express 3000 on startup. Normally, you won't make changes to this state. However, if you have opted to uncheck this box, you can use the connection features **Communication Port** and **Model** to re-define the connection, and when you click **Apply** this set-up is detected. You can also click the **Auto-Detect** button (under **pref-**

erences) to instruct the program to detect the connection without your assistance.

Automatically Detecting the Unit on Startup

To instruct the ADTRAN Express Configuration program to automatically detect on startup an Express 3000 unit on COM ports 1 through 4, check the **Auto-Detect Express 3000** checkbox (under **preferences**). This feature defaults to the auto-detect state. Uncheck the box to disable auto-detection.

ADTRAN recommends that you use this feature to automatically detect SPIDs and Switch Types, thus greatly reducing the occurrence of time-consuming problems.

Using Caller ID

Caller ID allows you to view the number of an incoming Voice or Audio call via a pop-up menu on your computer screen. To enable Caller ID, check the **Caller ID and capture COM port** checkbox (under **preferences**).

If you want Caller ID information to display on the screen when you are not using a terminal application or dial-up networking, check **Capture COM Port** on the Tray Tool menu (see also *Capture COM Port* on page 3-4).

You can also view information in the Caller ID log buffer (see *Displaying the Express 3000's Caller ID Log Buffer* on page 3-24).

Using Terminal Software for Diagnostics

You can specify a software program to use for diagnostic test purposes. Under **preferences > Terminal Software**, enter the **Program Name** and **Program Parameters**. With this information entered, when you click **Terminal** (under **diagnostics**), the program designated in these fields launches.

USING THE WIZARD

The Express Configuration Software **Wizard** option guides you through the process of configuring your Express 3000. Before activating the **Wizard**, ensure that the Express 3000 is connected to your computer and that it is powered on, and quit any programs that may be using the Express 3000. To activate the **Wizard**, click on the **wizard** option in the left panel. The window shown in Figure 3-7 opens.

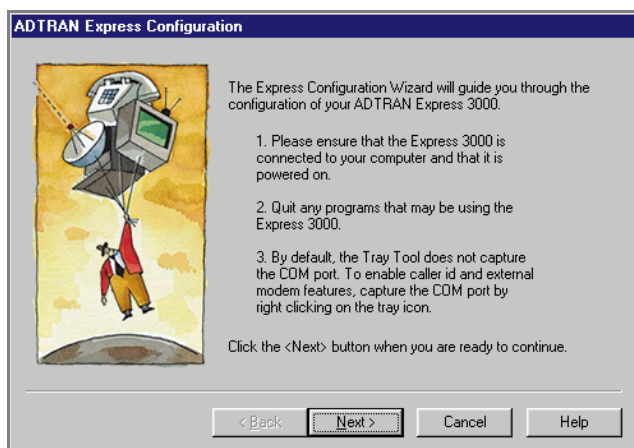
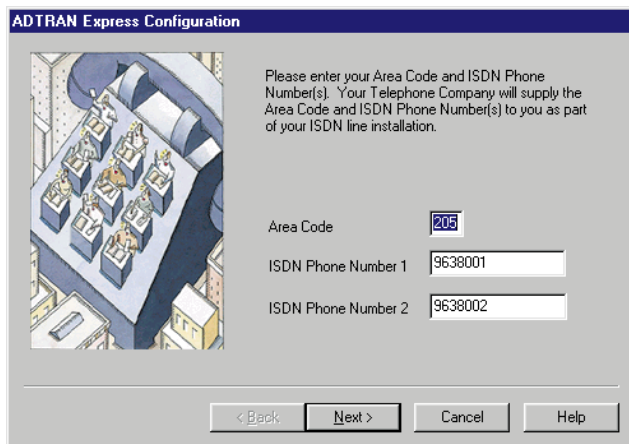

Figure 3-7. ADTRAN Express Configuration Wizard

As you follow the on-screen instructions and click **Next**, the figure shown in Figure 3-8 on page 3-29 opens and the Wizard prompts you to enter the following information: Area Code, ISDN Phone Number 1, and ISDN Phone Number 2. The telephone company from which you bought your ISDN service should provide you with this information. If you have problems with your ISDN service and need to contact an ISDN Support Center, see *Telephone Company Contacts for ISDN Service* on page ix.



The screenshot shows a window titled "ADTRAN Express Configuration". On the left is a 3D illustration of a telephone keypad. On the right, there is instructional text: "Please enter your Area Code and ISDN Phone Number(s). Your Telephone Company will supply the Area Code and ISDN Phone Number(s) to you as part of your ISDN line installation." Below the text are three input fields: "Area Code" with the value "205", "ISDN Phone Number 1" with the value "9638001", and "ISDN Phone Number 2" with the value "9638002". At the bottom are four buttons: "< Back", "Next >", "Cancel", and "Help".

Figure 3-8. Window for Entering ISDN Phone Numbers

When you click **Next** again, a new window opens (see Figure 3-9) for entering the Switch Type, SPID 1, and SPID 2; however, you may not need to enter this information as the Wizard uses advanced features to auto-detect SPIDs and Switch Type.

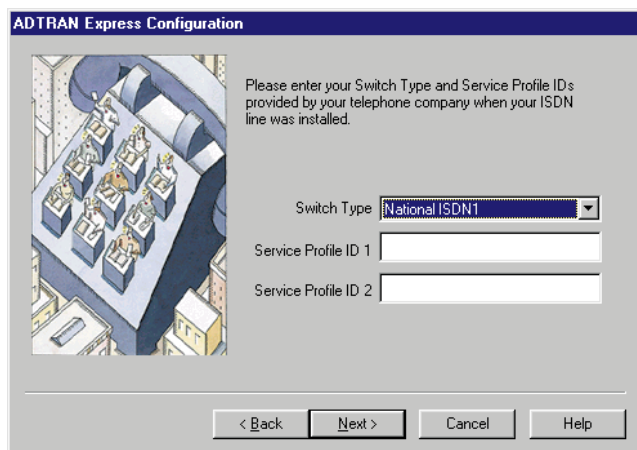

The screenshot shows a window titled "ADTRAN Express Configuration". On the left is a 3D illustration of a telephone keypad. On the right, there is instructional text: "Please enter your Switch Type and Service Profile IDs provided by your telephone company when your ISDN line was installed." Below the text are three input fields: "Switch Type" with a dropdown menu showing "National ISDN1", "Service Profile ID 1" (empty), and "Service Profile ID 2" (empty). At the bottom are four buttons: "< Back", "Next >", "Cancel", and "Help".

Figure 3-9. Window for Entering SPID Numbers

Automatically Running the Wizard on Startup

To instruct the ADTRAN Express Configuration program to automatically run the Wizard on startup, check the **Auto-Run Wizard** checkbox (under **preferences**). To disable this feature, uncheck the checkbox.

LOCATING INFORMATION ABOUT THE PROGRAM

To find the version number and registration information about the ADTRAN Express Configuration program, click on **about** on the left panel of the GUI.

Chapter 4 Using VT-100 Terminal Emulation

You can configure the Express 3000 using any communications package that supports VT-100 terminal emulation. Ensure that the Express 3000 is properly connected to your PC and that it is powered on before you try to configure your unit.

Configuring the Express 3000 Using VT-100 Terminal Emulation	
Step	Action
1	Connect to a VT-100 terminal using a communications package such as HyperTerminal.
2	At the prompt, enter the command AT!V and press the Enter key. (<i>The Configuration screen displays; see Figure 4-1.</i>)
 NOTE	<i>The AT command is not visible as you type since echo is off by default. To enable echo, type ATE1.</i>
3	Enter the following information: <ul style="list-style-type: none">• Area Code• ISDN phone number 1• ISDN phone number 2
4	Enable Auto-Detect SPIDs/Switch and any other changes.
5	Enter Ctrl + X to exit the menu.

```

Express 3000 Configuration Menu
1) Area Code = 256                17) Profiles
2) ISDN Phone Number 1 = 5551000 18) Configure Remote Unit
3) ISDN Phone Number 2 = 5553000 19) Remote Num. Password =
4) Auto-Detect SPIDs/Switch = Disabled
5) Switch Type = National ISDN1
6) Call Type = Data 64K
7) SPID 1 =
8) SPID 2 =
9) Auto Answer = Enabled
10) Call Screening = Answer Any
11) Call Routing = Speech/Audio->POTS
12) DTR Options = Ignore DTR
13) Flow Control = Hardware Flow
14) Protocol = PPP Asyn-Sync
15) PPP Mode = Multilink PPP
16) AO/DI = Disabled

Select = _          Enter SELECT   Esc NO CHANGE

Ctl-V STATUS  Ctl-T TEST  Ctl-C CONFIG  Ctl-D DIAL  Ctl-X EXIT
    
```

Figure 4-1. VT 100 Terminal Configuration Menu

Accessing Terminal Menus

After establishing a VT-100 terminal emulation session, you can go to a particular menu by pressing the hot key sequence for that menu (see Table 4-1). If the hot keys don't work, ensure that the communications package is configured to pass these control sequences through to the Express 3000.

Table 4-1. Menu Hot Keys

Menu	Hot Keys
AODI	(Ctrl + A)
CONFIG	(Ctrl + C)
DIAL	(Ctrl + D)
STATUS	(Ctrl + V)
TEST	(Ctrl + T)



The communications package must be configured to pass these control sequences through to the Express 3000.

Exiting the Terminal Menus

To exit the terminal menus, type **Ctrl + X**.

Placing the Unit Back On-line

The **Ctrl + X** command also places the unit back on-line if a call is connected.

Displaying the Status Buffer

Once you have accessed the terminal menus, type **Ctrl + V** at any time to display the Express 3000 **Status** menu (see Figure 4-2) which contains the Status Buffer.

```

Express 3000 Status Menu
UNIT/LOOP STATUS          STATUS BUFFER
Call Type                 = Data 64K          1 = NT WakeUpTone
DTE Rate                  = 9600             2 = NT WakeUpTone
Self Test                 = Passed           3 = NT WakeUpTone
Software Rev              = x.10            4 = NT WakeUpTone
Checksum                  = 1aaf            5 = NT WakeUpTone
Serial Number             = 823A8792        6 = NT WakeUpTone
Loop Status               = Link Down       7 = NT WakeUpTone
Num Dialed                = No Call         8 = NT WakeUpTone
RTS                       = On              9 = NT WakeUpTone
CTS                       = On             10 = NT WakeUpTone
DCD                       = Off            11 = NT WakeUpTone
DTR                       = On             12 = NT WakeUpTone
                           13 = NT WakeUpTone
                           14 = NT WakeUpTone
                           15 = NT WakeUpTone
                           16 = NT WakeUpTone
                           17 = NT WakeUpTone
                           18 = NT WakeUpTone
                           19 = NT WakeUpTone
                           20 = NT WakeUpTone
Ctrl-V STATUS  Ctrl-T TEST  Ctrl-C CONFIG  Ctrl-D DIAL  Ctrl-X EXIT  12:36:58_

```

Figure 4-2. VT 100 Terminal Status Buffer Menu

STATUS BUFFER MESSAGES

Status Buffer messages provide information about call progress, ISDN link status, and error conditions (see Figure 4-2 on page 4-3). The Status Buffer contains only the last 20 status messages, with relevant status items, generated during unit operation. The most recent status message appears as Status 1, with the remaining status messages appearing in descending order. Appendix B, *Status Buffer Messages*, lists the Status Buffer messages and their descriptions.

Chapter 5 Optional Calling Features

The Express 3000 fully supports optional calling features such as three- or six-way call conferencing, call forwarding, caller ID, call return, call holding, call transfer, call rejection, call waiting, and message waiting. To use these features, your touch-tone telephone must connect to POTS 1 (see *Connecting Your Primary Telephone* on page 2-11).



These features are available only if included in the ISDN service to which you subscribe.

CALL CONFERENCING

Call Conferencing (also known as three-way calling) permits a conversation between three to six parties, each at different locations.

Instructions for Call Conferencing	
Step	Action
1	Establish a voice call.
2	Flash-hook (i.e., press the FLASH button on the telephone key pad) to put the first party on hold and receive a second dial tone.
3	Dial the second party.
4	Repeat steps 2 and 3 as necessary.
5	Flash-hook again to connect all callers.

CALL FORWARDING

If subscribed to, this service forwards incoming calls to a different number. This action occurs after a certain number of rings or if the line is in use (busy).

CALLER ID

Caller ID displays a caller's name and phone number in a Caller ID box.

CALL RETURN

With this feature, your telephone automatically dials the last incoming call.

CALL REJECT

The Express 3000 provides two methods for rejecting incoming calls: using a call reject list and rejecting anonymous calls. Both of these features are enabled and disabled from the **Phone List** tab which opens when you are working with User profiles.

Call Rejection List

The Call Rejection List compares all incoming Speech and Audio calling party numbers to a user-created list of ten numbers that the user wants rejected. If a match is found, the POTS port will not ring. Generally, the caller experiences a busy signal. To find out if calls have been rejected, users must view the Status Buffer for rejection messages.

Anonymous Call Rejection

Sometimes callers block a party number so that you cannot see who is calling in (i.e., an anonymous call). These numbers normally appear as *Private* on a Caller ID unit. If the Anonymous Call Rejection feature is

enabled, anonymous calls will not ring the POTS port. Generally, the caller experiences a busy signal. To find out if calls have been rejected, users must view the Status Buffer for rejection messages.

CALL WAITING

Call Waiting permits one voice call to be placed on hold while answering another voice call. To enable this option, follow the instructions below.

Instructions for Enabling Call Waiting	
Step	Action
1	Flash-hook (i.e., press FLASH button on telephone keypad) to place the active call on hold and answer an incoming call.
2	Flash-hook as necessary between the two calls.
3	Hang up to terminate both calls.

Controlling Call Waiting

Call waiting can be disabled and enabled on a *per-call* basis. When disabled, you do not hear the call waiting tone.

Instructions for Enabling/Disabling the Call Waiting Tone	
To...	Do this...
Disable	Using a touch-tone phone, press *70 .
Enable	Hang up; the Express 3000 defaults to call waiting.

MESSAGE WAITING INDICATOR

If your ISDN line provisioning includes a Message Waiting Indicator, a stuttered dial tone is present on the POTS port when a message is unread. The stuttered dial tone is only present on the directory number on which a Message Waiting Indicator has been provisioned. Once a message is read, the stuttered dial tone stops.

When connecting to a National ISDN 1 switch, call conferencing, message waiting, and call transferring are assigned a unique feature identifier number. This number may not be the same in all areas.



S-registers 90 through 93 (see Appendix A) contain the calling feature identifier numbers used by the Express 3000. If these numbers do not work in your area, contact your ISDN provider.

POTS PORTS DISTINCTIVE RINGS

You can set up the Express 3000 so that POTS ports 1 and 2 have distinctive rings that are easily recognized. S-register 19 controls this feature (see *S-Registers* on page A-2).

Chapter 6 Upgrading Software

Software upgrades provide you with new and improved features. The Express 3000 flash-memory upgrades the software from a file provided by ADTRAN. To check the software version currently running, click on the **about** tab of the Express Configuration program or view the **Status** menu via a VT-100 terminal emulation session.

Use the Express Configuration program or a VT-100 terminal emulation program that supports the XMODEM or XMODEM 1K protocols (such as HyperTerminal) to upgrade your software. This chapter provides instructions for upgrading software using the Express Configuration program and using HyperTerminal.



If a terminal emulation package other than HyperTerminal is selected, please see the instructions supplied with the package to set up an XMODEM or XMODEM 1K connection.

UPGRADING FILES USING THE EXPRESS CONFIGURATION PROGRAM

Instructions for Upgrading Software Using the Express Configuration Program	
Step	Action
1	Download the necessary upgrade files from the ADTRAN web site (www.adtran.com).
2	Open the Express Configuration program. (If necessary, see <i>Opening the Program</i> on page 3-2 for detailed instructions.)

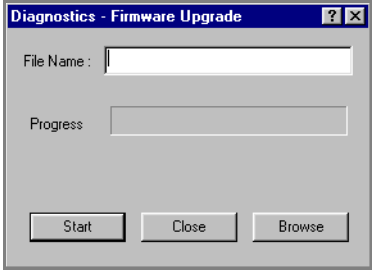
Instructions for Upgrading Software Using the Express Configuration Program	
Step	Action
3	Click on the Express Configuration program option labeled diagnostics .
4	Enter the file name in the File Name field, or Browse for the right file.
5	<p>Click the Start button to start the software upgrade process.</p> <p><i>When the software upgrade is complete, a message displays indicating the status of the software upgrade.</i></p> <p><i>(If the software upgrade failed, see Troubleshooting on page 8-1.)</i></p> 
NOTE	<p><i>During the software upgrade process, the PWR/LINE LED is no longer illuminated. Only the TD LED flashes during the software upgrade process. Once the process is complete, the Express 3000 automatically resets.</i></p>
6	Close the Express Configuration program when you have finished.

UPGRADING SOFTWARE USING HYPERTERMINAL

Instructions for Upgrading Software Using HyperTerminal	
Step	Action
1	Download the necessary upgrade files from the ADTRAN web site (www.adtran.com).
2	<p>Connect to the Express 3000 via HyperTerminal:</p> <p>a. Windows 95 Start > Programs > Accessories > HyperTerminal</p> <p>Windows 98 Start > Programs > Accessories > Communication > HyperTerminal</p> <p>b. When the Connection Description window opens, type in a connection name, select an icon, and click OK.</p> <p>c. In the Connect To window, go to the Connect using field and select the COM port to which the Express 3000 is connected; click OK.</p> <p>d. The COM port Properties window opens next. Change the Bits per second field to 57600 and click OK.</p>
3	<p>Type AT!FLASHLOAD to initiate the firmware update.</p> <p><i>The AT command is not visible since echo is off by default. (To enable echo, type ATE1.)</i></p>
4	Click the Transfer menu; then click Send File....
5	Click Browse to locate the directory and file to download to the Express 3000.

Instructions for Upgrading Software Using HyperTerminal

Step	Action
6	Change the Protocol to 1K Xmodem and click Send .
7	Once the download is complete, exit HyperTerminal, saving the session if desired. <i>The software upgrade is now complete.</i>

**NOTE**

If the PWR/LINE, B1 and B2 LEDs are flashing, the software upgrade failed. (In this case, see Troubleshooting on page 8-1.)

Chapter 7 Installing an Analog Modem

If you are using a PC running Windows 95/98, you can connect an external or internal analog modem to the Express 3000 and access an Internet Service Provider or host server that does not support ISDN. When you check **Enable Modem** (on the Tray Tool Menu), all commands sent to the COM port connected to the Express 3000 are passed to the external analog modem; therefore, commands cannot be sent to the Express 3000 when this mode is active. To resume communication with the Express 3000, uncheck **Enable Modem**.



Windows NT 4.0 does not support this feature.

This chapter describes the installation procedures for both external and internal modems.

EXTERNAL ANALOG MODEM APPLICATION

To use an external analog modem with the Express 3000, you will need the following items *in addition to* the items provided with the Express 3000:

- External analog modem
- EIA-232 serial cable
- RJ-11 to RJ-11 telephone cable
- 16550 UART high-speed serial port (but only for data rates of 230.4 kbps)

Figure 7-1 illustrates the setup for an external analog modem connected to the Express 3000. This setup requires one PC COM port and supports DTE rates of up to 115.2 kbps.

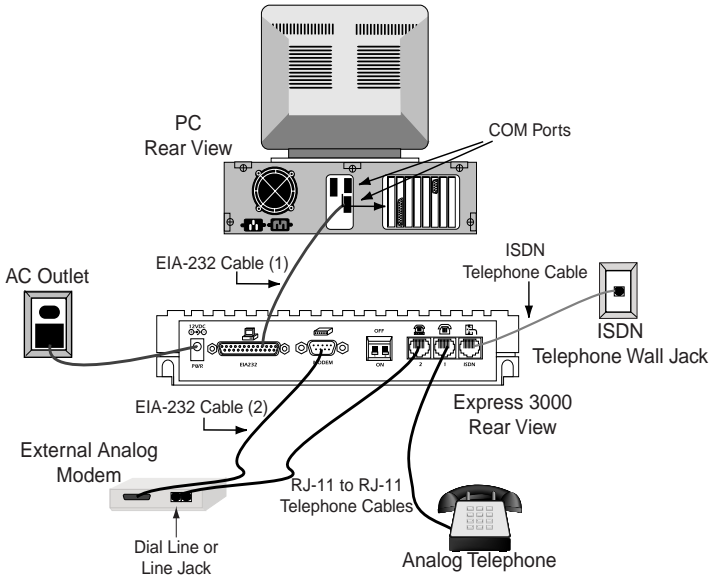



Figure 7-1. External Analog Modem Application



EIA-232 cable 1 (provided with the Express 3000) connects the Express 3000 to the PC. EIA-232 cable 2 (provided by the user) connects the external analog modem to the Express 3000.

Connecting an External Analog Modem

To connect an external analog modem to the Express 3000 use the following procedure:

Instructions for Connecting an External Analog Modem	
Step	Action
1	Ensure that the Express 3000 is connected to the PC via the provided EIA-232 cable, and that the PC is turned on.
2	Ensure that the modem power is off (i.e., it's not plugged in).
3	Connect one end of the second EIA-232 serial cable to the external analog modem and the other end to the Express 3000 port labeled MODEM (an illustration of a modem is positioned above this port).
 NOTE	<i>Incoming calls must use ISDN phone number 2 for external analog applications.</i>
4	Connect one end of the RJ-11 to RJ-11 telephone cable to POTS port 2 on the Express 3000 (an illustration of a telephone above a modem is positioned above this port) and the other end to the Dial Line or Line jack on the external analog modem. (See the external analog modem's documentation to determine which modem jack is the Dial Line or Line jack.)
5	Power on the external analog modem (i.e., plug it in). <i>(The external analog modem is now connected to the Express 3000.)</i>

If you are connecting an external analog modem that has already been in use by a PC running Windows 95/98, you are ready to use the external analog modem. Enable the external analog modem using either

the Express Configuration program (Tray Tool Menu) or by using a VT-100 terminal emulation package (such as HyperTerminal).

If you are connecting an external analog modem that has not been used by a PC running Windows 95/98, you must configure it before you can use it (see *Configuring the External Analog Modem* on page 7-4).

Configuring the External Analog Modem

To configure the external analog modem, set up the communications software so it uses the same serial COM port to which the Express 3000 is connected.

To install and use an external modem that does not support 230.4 kbps, set **DIP Switch 1** on the back panel of the Express 3000 to **ON (down)**, thus limiting the DTE speed to 115.2 kbps. To re-enable the 230.4 kbps operation for ISDN connections, set **DIP Switch 1** to the **OFF (up)** position.

When using an external analog modem that does not support 230.4 kbps with applications that support Express 3000 operation at 230.4 kbps, attach the Express 3000 to the high-speed 16650 UART COM port and connect the external analog modem to a separate COM port. This setup allows the Express 3000 to operate at 230.4 kbps and the external modem to operate at the reduced speed.

Setting the Carrier Detect Signal

Before enabling the modem using the Express Configuration program, set the **Carrier Detect** (CD) signal from the modem to **Normal** (track CD signal). Use the AT command **AT&C1** to do this. To enter AT commands into the modem, open a VT-100 terminal emulation session and enter the following (<cr> indicates you should press the **Enter** key to insert a carriage return):

Command	Function
<code>AT_L1 <cr></code>	Enables external analog modem.
<code>AT <cr></code>	OK response (sets modem baud rate).
<code>ATI <cr></code>	Identifies the modem (verifies modem connected).
<code>AT&C1 <cr></code>	Sets CD to normal.
<code>AT&W <cr></code>	Saves settings.
<code>AT_L0 <cr></code>	Disables external analog modem.

CONTROLLING AN EXTERNAL ANALOG MODEM

You can enable and disable (control) an external modem with the Windows 95/98 Tray Tool Menu (see *Launching the Tray Tool* on page 3-3) or with VT-100 terminal emulation (discussed here). When the Express 3000 enables the external modem port, the external analog modem RTS and CTS lines directly switch over to the PC COM port. This switching process allows the external analog modem to provide flow control as normal. Once the modem is enabled, all further COM activity transmits to the external analog modem. When the modem is disabled, the ISDN terminal adapter within the Express 3000 processes all further COM port activity.

Controlling the Modem via Terminal Emulation

Another method of controlling an external analog modem is using a VT-100 terminal emulation package such as HyperTerminal. First, determine if the external analog modem is properly connected to the Express 3000 by typing the AT command `AT!Z` and pressing the **Enter** key. If properly connected, the Express 3000 responds with the message **MODEM FOUND**. If the external analog modem is not properly connected, the Express 3000 responds with the message **NO MODEM FOUND**.



*The `AT!Z` command is directed to the Express 3000, not the analog modem itself. An **ERROR** occurs if the command is sent while the external analog modem is enabled.*

Using VT-100 Terminal Emulation to Enable/Disable the Modem	
To do this...	Enter this AT Command
Enable modem	AT_L1 and press the Enter key
Disable modem	AT_L0 and press the Enter key

When carrier detect (CD) is active (i.e., a call is connected) on the external analog modem, the Express 3000 will not switch control from the modem port when you attempt to disable it. The call must be hung-up (disconnected) to deactivate CD, before you can switch control from the modem port and disable it.

INTERNAL ANALOG MODEM APPLICATION

The following items are necessary to connect an internal analog modem to the Express 3000:

- Internal analog modem
- RJ-11 to RJ-11 telephone cable

When using an internal analog modem with the Express 3000, two COM ports are assigned on the PC and configured independently. See the manufacturer's documentation for internal analog modem configuration.

Figure 7-2 on page 7-7 illustrates the connections for installing an internal modem to the Express 3000.

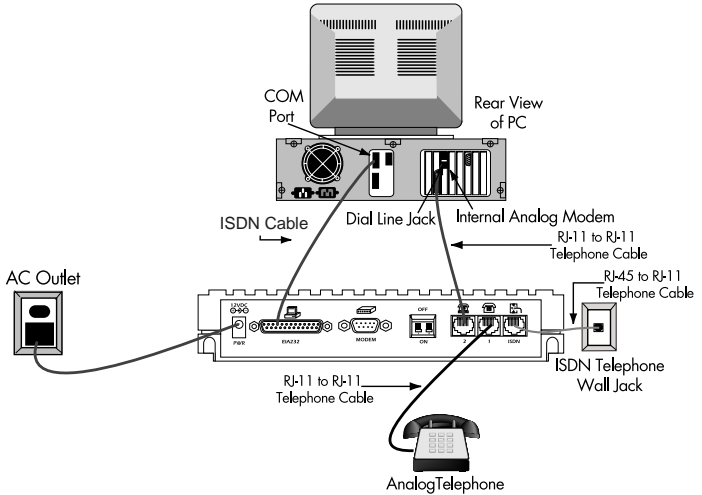

Figure 7-2. Internal Analog Modem Connections

Connecting an Internal Analog Modem

To connect an internal analog modem to the Express 3000, use the following procedure:

Instructions for Connecting an Internal Analog Modem	
Step	Action
1	Ensure that the Express 3000 is connected to the PC.
2	Connect one end of the RJ-11 to RJ-11 telephone cable to the telephone jack labeled 2 on the Express 3000.
3	Connect the other end of the RJ-11 to RJ-11 telephone cable to the Dial Line or Line jack on the internal analog modem.



*See the internal analog modem documentation to determine which jack on the internal analog modem is the **Dial Line** or **Line** jack.*

TROUBLESHOOTING GUIDELINES

This section provides troubleshooting techniques to resolve problems that may be encountered while operating the Express 3000. If problems persist, contact ADTRAN technical support for assistance (see the inside back cover of this manual for more information). Topics covered in this chapter are listed below:

- *PWR / LINE LED is off.* See page 8-2
- *PWR / LINE LED flashes, and 1 and 2 LEDs are off.* See page 8-2
- *PWR / LINE LED, and 1 and 2 LEDs flash green.* See page 8-2
- *Dial-up connection problems.* See page 8-4
- *Auto-detect Switch SPIDs remains at Link Down.* See page 8-5
- *Express 3000 not detected.* See page 8-6
- *External analog modem not detected.* See page 8-6
- *Difficulty with 230.4 kbps operation.* See page 8-7
- *Dial-up networking difficulty.* See page 8-7



PWR / LINE LED is off.

This indicates a problem with the power to the unit.

1. Verify that the power cord is connected to the Express 3000, and that it is plugged into a working 120 volt AC electrical outlet.



PWR / LINE LED flashes, and 1 and 2 LEDs are off.

This indicates a problem with the physical connection of the ISDN line between the Express 3000 and the local telephone company.

1. Verify that the large end of the ISDN telephone cable (provided with the Express 3000) is connected to the ISDN connector on the rear panel of the Express 3000.
2. Verify that the small end of the same ISDN telephone cable is connected to the ISDN telephone wall jack that is installed with a Basic Rate ISDN.
3. If steps 1 and 2 do not solve the problem, contact your local telephone service provider.



PWR / LINE LED, and 1 and 2 LEDs flash green.

This indicates a configuration problem.

1. Verify that the following information has been correctly entered:
 - Switch Type
 - Service Profile Identifiers (SPIDs)
 - ISDN Phone Numbers



PWR / LINE LED, and 1 and 2 LEDs flash green. (Continued)

- a. To verify this information, click **Register Dump** under **diagnostics** on the ADTRAN Express Configuration window, or click **Configuration Screen** in the VT-100 menu system. To invoke the VT-100 menu system, issue the AT command **AT!V** from a terminal emulation package such as HyperTerminal.)
 - b. You can also use **Auto-Detect Express 3000** (under **preferences**) to automatically detect the SPIDs and the Switch Type. In the ADTRAN Express Configuration program, click **wizard** on the Express Configuration window or, use the **Auto-Detect SPIDs / Switch** option in the **Configuration** screen of the VT-100 menu system. (To invoke the VT-100 menu system, issue the AT command **AT!V** from a terminal emulation package such as HyperTerminal.)
 - c. If all configuration information is correct, and the unit is properly connected, **Link Status** indicates **Link Up**. If the link status is good and calls still cannot be placed, refer to page 8-4.
2. Look for the following with the COM port setup:
 - IRQ conflicts
 - Wrong DTE speed



NOTE

If the PWR /LINE LED, and 1 and 2 LEDs flash green, sequentially, after a software upgrade, a problem occurred during the download. Restart the download using the instructions in Chapter 6. If the download fails a second time, contact ADTRAN technical support (see inside back cover).



Dial-up connection problems.

A variety of causes may result in dial-up connection problems.

1. Status Buffer messages returned from the ISDN network and the Express 3000 can help diagnose many dial-up connection problems.
 - a. Access these messages by clicking **Status Buffer** (Local or Remote) on the **diagnostics** option on the ADTRAN Express Configuration window.
 - b. Alternatively, you can access the **Status Buffer** by using the key sequence **Ctrl+V** in the VT-100 menu system. (To invoke the VT-100 menu system, issue the AT command **AT!V** from a terminal emulation package such as HyperTerminal.)
2. Ensure the following to verify the correct protocol is selected:
 - PPP or V.120 generally for Internet applications
 - V.120 or Multilink PPP for work-at-home



Auto-detect Switch SPIDs remains at Link Down.

A **Link Down** condition persisting for longer than five minutes indicates a problem with the ISDN line provided from the telephone company. Usually, the ISDN physical layer device has been unable to synchronize to the network.

1. Verify that the Express 3000 is powered on.
2. Verify that the provided ISDN telephone cable is correctly installed between the Express 3000 and the ISDN wall jack.
 - a. If the wall jack does not have ISDN installed on the two middle pins (tip and ring), the Express 3000 will never synchronize to the telephone switching equipment.
 - b. Call the local telephone company and have them check the ISDN line for correct operation.



Express 3000 not detected.

The Express 3000 may not be detected for several reasons.

1. Verify the following:
 - a. The Express 3000 is powered on.
 - b. No other applications are running that could be using the COM port to which the Express 3000 is attached.

A Windows application does not have to be active to tie up a COM port. Be sure to check the Windows 95/98 Taskbar for any suspended applications (such as HyperTerminal) that may be using the COM port. If any applications are minimized, they must be closed **before** starting the ADTRAN Express Configuration program.

2. If you are operating at 230.4 kbps, move **DIP switch 1** to **Off (up)**.
3. Confirm that the computer has a 16650 UART.



External analog modem not detected.

Verify the following:

1. The external analog modem is powered on.
2. The external analog modem is properly installed and configured for use with the Express Configuration program.



Difficulty with 230.4 kbps operation.

If the Express 3000 does not work when the DTE rate is set (inside Windows) to 230.4 kbps, verify the following:

1. **DIP switch 1** on the back of the Express 3000 is set to **Off (up)**.
2. A high-speed serial card with a 16650 UART is being used, and the software drivers to support the extended baud rate tables are installed.



Dial-up networking difficulty.

1. If Windows 95/98 Dial-Up Networking cannot talk to the Express 3000, check the modem configuration for the Express 3000 and ensure the bit rate for the DTE is set correctly.
2. If the PC is not equipped with a 16650 UART, then the fastest DTE operation speed is 115.2 kbps; ensure the speed is not higher than the PC and modem can support.

Appendix A AT Commands and S-Registers

AT COMMANDS

AT commands issue directions to the Express 3000 via a VT-100 terminal emulation session. The DTE serial port accepts AT commands only when no calls are established; i.e., the carrier detect (CD) signal is inactive. When a call is established, the CD signal is active and the port is used for data. The port cannot be used simultaneously to issue AT commands and transmit and receive data. After entering command mode (CD inactive), you can transmit AT commands to the Express 3000 to configure most options, dial remote Express 3000s, and initiate tests to check both the Express 3000 and the network connections.

Escape Sequence and Guard Time Delay

To exit data mode (CD active) and enter command mode, the DTE serial port must transmit a proper escape sequence to the Express 3000. A specified time delay must occur between the last data character and the first escape sequence character. This delay is the guard time delay. You can change the guard time by writing a value to the S12 register. For a valid escape sequence to occur, the DTE must transmit the escape code character *three* times in succession with the delay between each character less than the guard time.

The default escape sequence is +++ and the default guard time delay is one second.

Entering Text into the Command Line

All command lines must begin with the **AT** character set in either all uppercase or all lowercase letters. After the **AT** attention code, the command line may contain a single command or a series of commands; however, AT commands **_L1** and **_L0** must be entered on a separate line and followed by **Enter**. When entering a series of commands, you may separate the individual commands with spaces for readability. The maximum length for a command line is 40 characters.

After receiving a terminating character, the Express 3000 executes each command line. The default terminating character is a carriage return (ASCII 013), but it can be changed by writing a different value to register S3. Before transmitting the terminating character, you can edit the command line by using the backspace character (ASCII 008) to erase errors so the proper commands can be entered.



NOTE

*To return an active call to the on-line state, enter **ATO**.*

Entering AT Commands

To enter an AT command, type **AT** followed by the command; then, press the **Enter** key (the AT Commands list begins on page A-4). For example, **ATI1** returns the software version of the Express 3000 unit.

S-REGISTERS

You can change or view the Express 3000 configuration using the S-registers (the S-registers list begins on page A-9).

Reading S-Registers

To read an S-register, type **AT**, the S-register number, a question mark, and then press the **Enter** key. For example, **ATS0?** lets you view the Auto Answer options.

Changing S-Registers

To change an S-register, type **AT**, the S-register number to change, an equals sign, the numeric value to assign to the register, and then press the **Enter** key. For example, **ATS0=2** changes the Auto Answer to 2 (dump all calls).

S-REGISTER STRINGS

S-register Strings store strings of digits such as stored phone numbers and SPIDs (the S-registers String list begins on page A-16).

Reading S-Register Strings

To read an S-register String, type **AT**, the number of the string S-register to read, a question mark, and then press the **Enter** key. For example, **ATSS80?** shows the number stored in location 0.

Changing S-Register Strings

To change an S-register string, type **AT**, the number of the S-register string to change, an equals sign (=), the numeric string to assign to the register, and then press the **Enter** key. **ATSS80=5551212**, for example, changes the number stored in location 0 to 5551212.

Dialing a Call using AT Commands

To dial a call using the DTE terminal and AT commands, on one line type **ATD**, **ATDT**, or **ATDP** and the telephone number; then press the **Enter** key. For example, **ATD5551212** dials phone number 555-1212.

Disconnecting a Call using AT Commands

To end an active call using the AT commands, press the break-in key sequence **+++**. Then type **ATH** and press the **Enter** key to hang up the line.

AT Commands List

(Type **AT** and then type the command.)

Command	Function
A	Answer. Places the Express 3000 in answer mode.
!DAY	Current date in the format of DDMMYY.
!FLASHLOAD	Initiate the flash software update. The terminal must be set for 57,600 bps, 8 data bits, no parity, and 1 stop bit.
!NAME1	Displays the Calling Party name from the last call on POTS port 1.
!NAME2	Displays the Calling Party name from the last call on POTS port 2.
!NUMBER1	Displays the Calling Party number from the last call on POTS port 1.
!NUMBER2	Displays the Calling Party number from the last call on POTS port 2.
!S	Displays Status Buffer.
!S1	Displays Link Status.
!TIME	Current time in the format of HHMMSS.
!V	Configuration Menu.
!Z	Detect a modem connected to the Express 3000.
D	Dial. Precedes the telephone access number [ATD5551212].
H	Hang up. Disconnects the current call.
I0	Identify unit. Commands the unit to display model number.
I1	Identify software. Commands the unit to display software version.
O	On-line. Commands the unit to go back on line.
S	S Register.
SS	S String register.
&V	Displays the contents of all S registers.
Z	Reset. Resets the AT command processor.
&W	Save. Save current configuration to EEPROM.
+++	Break in. Break in AT command processor during an active call. The break in key is defined in S2.
_Z	Resets unit.
_F	Restores factory defaults.

Carrier Detect (CD) Control Line Options

Command	Function
&C0	CD forced on.
&C1	CD normal.
&C2	CD off with local disconnect (LOCD).
&C3	CD off with link down.

Data Terminal Ready (DTR Control Line Options)

Command	Function
&D0	Ignore DTR.
&D1	DTR off forces command.
&D2	Idle when off. DTR off forces idle. (On allows auto answer.)

Generic Unit Configurations

Command	Function
&F0	Factory Default. Restores last-saved configuration.
&F1	Internet 64K.
&F2	Internet 128K.
&F4	Remote Access 128K.
&F7	Configures unit for Dial 57.6k async.
&F8	Configures unit for Dial 115.2k async.
&F11	Configures unit for FALLBACK.

Calling Number Identifiers

Command	Function
&N0	Number 1. Read far-end phone number 1 if service subscribed from telephone company.
&N1	Number 2. Read far-end phone number 2 if service subscribed from telephone company.

Clear-To-Send (CTS) Control Line Options

Command	Function
&R0	Follows RTS.
&R1	Forced CTS.

Data Set Ready (DSR) Control Line Options

Command	Function
&S0	DSR forced on.
&S1	DSR if call up.
&S2	DSR off if link down.

Dialing Options: Accessing Stored Numbers

Command	Function
&Z0	Stored number 0
&Z1	Stored number 1
&Z2	Stored number 2
&Z3	Stored number 3
&Z4	Stored number 4
&Z5	Stored number 5
&Z6	Stored number 6
&Z7	Stored number 7
&Z8	Stored number 8
&Z9	Stored number 9

Local Echo Options

Command	Function
E0	Echo off. Does not allow command characters typed to be displayed on the screen.
E1	Echo on. Allows the command characters typed to be displayed on the screen.

AT Command Response Message Options

Command	Function
Q0	Response messages on.
Q1	Response messages off.

AT Command Response Message Types

Command	Function
V1	Verbal response messages.

AT Command Connect Message Options

Command	Function
<code>x1-7</code>	Connect messages with DTE rate.

Ready-To-Send (RTS) Control Line Options

Command	Function
<code>_D1</code>	18 mS delay.

ISDN Switch Type Options

Command	Function
<code>_S1</code>	DMS-100.
<code>_S2</code>	National ISDN-1.

Data Flow Control Options

Command	Function
<code>\Q0</code>	No flow control.
<code>\Q1</code>	Software flow control (XON/XOFF).
<code>\Q2</code>	CTS only.
<code>\Q3</code>	Hardware flow control (RTS/CTS) factory default.
<code>\Q4</code>	Software from DCE only.

DTE and Modem Interface Selection

Command	Function
<code>_L0</code>	Disable external analog modem connected to the Express 3000 modem port.
<code>_L1</code>	Enable external analog modem connected to the Express 3000 modem port.

S-Registers List

Command	Function	Features
S00	Auto Answer	Determines how the Express 3000 answers an incoming call. 0 = Disable (Express 3000 does not answer call). 1 = Enable (Express 3000 answers all calls). 2 = Dump all calls.
S02	Escape Character	Determines which key or character (in ASCII code) defines the escape command. The standard escape character is a plus (+) sign (ASCII value of 43 decimal). To change the character set, set S2 to the desired ASCII value. Range = 0 to 127
S03	End of Line Character	Determines which key or character (in ASCII code) ends a command line. The standard end-of-line character is the carriage return (ASCII value of 13 decimal). Range = 0 to 127
S04	Line Feed Character	Determines which key or character (in ASCII code) advances the cursor to the next line after ending a command line or after an Express 3000 message. The standard character is the line feed (ASCII value of 10 decimal). Range = 0 to 127
S05	Back Space Character	Determines which key moves the cursor back one space to erase a character. The standard character is the backspace (ASCII value of 8 decimal). Range = 0 to 127
S06	Enable AO/DI	S6 = 0 for disable S6 = 1 for enable
S07	Connect Time	Determines how long the Express 3000 waits for an outgoing call to be answered. 15 = 15 seconds 30 = 30 seconds 60 = 1 minute 120 = 2 minutes 240 = 4 minutes

S-Registers List *(Continued)*

Command	Function	Features
s08	Call Rejection	Determines which incoming voice calls the Express 3000 will reject. 0=Disables 1=Reject anonymous calls only 2=Reject calls on call rejection list only 3=Reject anonymous and call rejection list numbers
s12	Escape Time	Determines the delay required immediately before and after entering the escape command for the Express 3000 to recognize and execute the command. Range = 0 to 127
s13	Spid Download Enable/Disable	0=Enabled 1=Disabled
s14	Misc Bits	Miscellaneous bits (bit 8 is most significant bit). Bit 2 = 1:Enables on screen echo of AT commands. Bit 2 = 0:Disables on screen echo of AT commands. Bit 3 = 0:Enables AT responses from the Express 3000. Bit 3 = 1:Disables AT responses from the Express 3000. Bit 4 = 1:Enables AT responses to be displayed in text form. Bit 4 = 0:Enables AT responses to be displayed in numeric form. Bit 7 = 1:Disable PPP ACCM spoofing. Bit 7 = 0:Enable PPP ACCM spoofing. Bit 8 = 1:Ring indicator uses cadence. Bit 8 = 0:Ring indicator remains on.
s15	Async Bonding	Asynchronous BONDING method. 0 = ADTRAN revision 0 (default) 1 = Multi-vender option
s19	Miscellaneous POTS	POTS features bit mapped register. Bit 0 = Set: Distinctive ring on. Bit 1 = Set: Busy/Ring for POTS Port 1 Bit 2 = Set: Busy/Ring for POTS Port 2 Bit 3 = Set: Bit 4 = Set: Bit 5 = Set: Disables call waiting for POTS Port 1. Bit 6 = Set: Disables call waiting for POTS Port 2. Bit 7 = Set:
s20	Read POTS	Debug only.
s21	Write POTS	Debug only.

S-Registers List *(Continued)*

Command	Function	Features
s22	Msg Bits	Miscellaneous message bits. Bit 4= Bit 5 = Bit 6 = Set: Connects message with baud rate.
s25	DTR Detect Time	Determines time, in hundredths of a second, that must elapse before the Express 3000 recognizes a change in DTR. Range = 0 to 255
s27	PPP Mode	Value determines whether or not PPP will be a single-link or multilink connection. 0=Single-link operation (default) 1=Multilink operation 2=Use compression
s30	DTE CTS	Controls the operation of the DTE connector CTS line. 0=Follows RTS 1=Force CTS
s31	DTE RTS	Controls operation of the RTS line. 0=1 ms delay 1=18 ms delay
s32	DTE DSR	Controls the operation of the Data Set Ready signal on the DTE connectors. 0=Force DSR on always 1=DSR off OOS + Test 2=DSR off Link Down
s33	DTE CD	Controls the operation of the Carrier Detect line on the DTE connectors. 0=Force CD on always 1=CD is active during a call (Normal Operation) 2=Off with LOCD 3=Off link down
s34	DTE DTR	Determines how the Express 3000 responds to changes in DTR. This is a bit-mapped register. 0=Ignore DTR 1=Force AT command mode when DTR is off 2=Dump incoming call when DTR is off 4=Hang up incoming call when DTR is off 8=Hang up outgoing call when DTR is off 16=Answer incoming call when DTR is on 28=Idle when off 32=Dial SN0 when DTR is on 64=Dial SN0 when DTR transitions from off to on

S-Registers List *(Continued)*

Command	Function	Features
s36	Inactivity Timer	0=Off 1-255=Number of idle minutes before disconnect
s37	Conference/ Call Waiting	Flash-hook button defaults to: 0=Call waiting 1=Call conferencing
s38	X25	TEI = 255
s40	Bond TXINIT	Specifies the number of seconds the originating endpoint attempts to detect the Async BONDING negotiation pattern from the answering endpoint before deciding the Async BONDING call has failed. 0 to 255, 10 sec is default.
s41	Bond TXFA	Specifies the number of seconds both endpoints attempt to detect the async BONDING frame pattern when a call is connected before deciding the async BONDING call has failed. When operating with other manufacturer's async BONDING equipment, it may be necessary to lengthen this timer so that it matches TXADD01. 0 to 255, 10 sec is default.
s42	Bond TXADD	The number of seconds both endpoints wait for the additional call to be connected at the end of negotiation before deciding the async BONDING call has failed. When dialing overseas it may be necessary to lengthen this timer to allow for slower call routing. 0 to 255, 50 sec is default
s43	Bond TXDEQ	The number of seconds both endpoints attempt to equalize the network delay between the bearer channels before deciding the Async BONDING call has failed. 0 to 255, 50 sec is default
s44	Bond TANULL	The number of seconds the answering endpoint attempts to detect the Async BONDING negotiation pattern from the originating endpoint before aborting to clear channel mode. It may be necessary to shorten this timer if the DTE equipment connected to the Express 3000 also has timer constraints for completing non-BONDING parameter negotiation. 0 to 255, 10 sec is default

S-Registers List *(Continued)*

Command	Function	Features
s45	Bond TCID	The number of seconds both endpoints attempt to negotiate agreeable values for bearer channels and channel capacities before deciding the async BONDING call has failed. 0 to 255, 5 sec is default
s52	Switch Type	Selects the network switch type for dial service. 0=AT&T 5ESS 1=Northern Telecom DMS-100 2=National ISDN-1
s53	Call Type	Call type (Dial service only). 0=Speech 1=Audio 2=56 Kbps data 3=64 Kbps data
s54	Protocol Type	Rate adaption protocol type. 2=Async BONDING 6=V.120 11=Fallback 12=PPP async-to sync conversion
s58	Call Screening	Allows the Express 3000 to screen incoming calls. 0=Answer any call 1=Answer only calls from numbers matching those stored in SN0 through SN9.
s65	Expert ISDN	Sets the AutoSpid determination feature. 0=Disable (default) 1=Enable
s71	DTE Rate	Selects the DTE connector bit rate. 3 = 1200 6 = 2400 8 = 4800 11 = 9600 15 = 19200 17 = 38400 20 = 57600 23 = 115200 25 = 230400
s72	Data Bits	Selects the number of asynchronous data bits. 0 = 8 bits 1 = 7 bits

S-Registers List *(Continued)*

Command	Function	Features
s73	DTE Parity	Selects the number of asynchronous parity bits. 0=None 1=Odd 2=Even
s74	DTE Stop	Selects the number of asynchronous parity bits. 0=None 1=Odd 2=Even
s75	DTE Flow	Selects asynchronous flow control. 0=None 1=XON/OFF from DTE controls DCE 2=XON/OFF from DCE controls DTE 3=Hardware 12=Software
s90	Conference ID	NI-1 feature identification number for conferencing. See the ISDN service provider for this ID.
s91	Transfer ID	NI-1 feature identification number for transferring. See the ISDN service provider for this ID.
s92	Message Waiting ID	NI-1 feature identification number for message waiting indicator. See the ISDN service provider for this ID.
s93	Call Type Routing	Determines how incoming call is routed when connected to a point-to-point ISDN line. 0=Route all call types to DTE
s94	Local Tones	Forces the POTS interface to generate all tones. Bit 0=0:In-band tones from ISDN switch (when available) Bit 0 =1:All tones generated locally Bit 1 =0: Warnings to POTS when unavailable Bit 1 =1:Disable all warnings to POTS
s118	Chap Spoofing Enable	32 = CHAP enabled (Windows 95/98 setting) 0 = CHAP disabled
s147	Raise Threshold	0 -100% (Default = 50%) User selectable variables: 10, 20, 30, 40, 50, 60
s148	Lower Threshold	0 - 100% (Default = 30%) User selectable variables: 10, 20, 30, 40, 50, 60
s149	Drop Time	Default = 1 min Increments of 30 seconds (S149 = 1 for 30 s) User selectable variables: 30 s, 1 min, 2 min, 5 min

S-Registers List *(Continued)*

Command	Function	Features
s150	Add Time	Default = 30 sec Increments of 30 seconds (S150 = 1 for 30 s) User selectable variables: 30 s, 1 min, 2 min, 5 min
s151	Sample Time	Increments of 10 seconds (Default = 10 s) User selectable values: 10, 20, 30, 40, 60
s152	Number of B Channels	S152 = 0 for D only (Default) S152 = 1 for 1B S152 = 2 for 2B

S-register Strings List

SS60	SPID1 LOC	SPID string location.
SS61	SPID2 LOC	SPID string location.
SS62	LDN1 LOC	ISDN phone number string location.
SS63	LDN2 LOC	ISDN phone number string location
SS67	Area Code	Area code location.
SS77	Remote Numeric Password	Numeric password string for remote configuration.
SS80	SN0 LOC	Stored number 0 string
SS81	SN1 LOC	Stored number 1 string. Used for second number dialed in a multilink connection.
SS82	SN2 LOC	Stored number 2 string
SS83	SN3 LOC	Stored number 3 string
SS84	SN4 LOC	Stored number 4 string
SS85	SN5 LOC	Stored number 5 string
SS86	SN6 LOC	Stored number 6 string
SS87	SN7 LOC	Stored number 7 string
SS88	SN8 LOC	Stored number 8 string
SS89	SN9 LOC	Stored number 9 string
SS130	CR0 LOC	Call Reject List Number 0
SS131	CR1 LOC	Call Reject List Number 1
SS132	CR2 LOC	Call Reject List Number 2
SS133	CR3 LOC	Call Reject List Number 3
SS134	CR4 LOC	Call Reject List Number 4
SS135	CR5 LOC	Call Reject List Number 5
SS136	CR6 LOC	Call Reject List Number 6
SS137	CR7 LOC	Call Reject List Number 7
SS138	CR8 LOC	Call Reject List Number 8
SS139	CR9 LOC	Call Reject List Number 9
SS143	Packet Phone Number	X.25 Packet Number
SS146	BACP Dial Prefix	Dial prefix for B channels, if different from D channel.

Appendix B **Status Buffer Messages**

Status Buffer messages provide information about call progress, ISDN link status, and error conditions. The Status Buffer contains only the last 20 status messages, with relevant status items, generated during unit operation. The most recent status message appears as 1, with the remaining status messages appearing in descending order. Messages shown entirely in capital letters are generated by the ISDN network. Messages with lower case letters are generated by the Express 3000.

2047 BERT orig

Test remote originated 2047 BERT (bit error rate test) pattern.

2047 loopbk ansr

Test remote answered 2047 BERT pattern.

Answer

The Express 3000 answered a call on either the first or second channel. The calling phone number is displayed if available.

ACCESS_INFO_DISCARDED

The network was unable to deliver access information to the far end.

Area Code Req'd

Area code required for Auto Spid determination.

AutoSpid Active

Unit is attempting automatic detection of switch type and SPID numbers.

AutoSpid Disable

The user has stopped the automatic SPID detection process.

AutoSpid Failed

Automatic determination of switch type and SPID numbers failed.

AutoSpid Passed

Automatic determination of switch type and SPID numbers succeeded.

AutoSwitch YYY

Switch type YYY detected during AutoSpid determination. (YYY can be DMS, NI-1, or AT&T.)

Back to online

Express 3000 went back online.

Bad async BPS

The Bonding protocol determined that the selected asynchronous bit rate is not supported.

Bad AT numeric

User issued an AT command with an argument that was out of range.

Bad call type

Express 3000 placed a call with an improper call type.

Bad DTE Baud

The DTE bit rate does not match a valid bit rate for the protocol selected.

BAD_INFO_ELEM

Call control error.

Bad phone number

Express 3000 attempted to call an invalid phone number.

BEAR_CAP_NOT_AVAIL

The bearer channel requested is not available.

BEARER_CAP_NOT_AUTH

Bearer capability requested is not authorized.

Bearer Mode?

Incoming call is not of a type the Express 3000 can accept.

Bearer Info Cap?

Incoming call information transfer capability is not known.

BONDING (+/-XXX)

The amount of bytes or corrected delay between the B2 and B1 Bearer channels (XXX can range from -8000 to +8128).

BPS mismatch

Bonding negotiation found a bit rate mismatch.

Break to AT cmd

User issued a break-in request.

Break ignored

User issued an extra break-in request.

BUSY

The called number is busy.

B-X disconnected

B-channel disconnected. X can be 1 or 2 representing the appropriate B-channel.

CallID 1 in use

The Express 3000 tried to place a call using SPID 1 when SPID 1 was already in use.

CallID 2 in use

The Express 3000 tried to place a call using SPID 2 when SPID 2 was already in use.

Call lost

Held call could not be retrieved.

Call not ringing

User executed an answer command (ATA) but there was not a call present.

CALL_REJECTED

The call has been rejected by the ISDN network.

Can't go online

Express 3000 cannot go back on line. Unknown AT command user issued an unknown AT command.

CHAN_DOES_NOT_EXIST

The user asked for a bearer channel that is not present.

CHAN_NOT_IMPLEMENTED

The network or far end does not support the bearer capability requested.

CHANNEL_UNACCEPTABLE

The channel requested has not been subscribed.

CID>0 rcvd

Received an incoming call from a third party during negotiations with a far-end BONDING unit on the use of the second Bearer channel.

Connect Timeout

Call attempt does not connect in x amount of time.

DEST NOT ISDN

The number called is not ISDN (warning only).

DEST_OUT_OF_ORDER

The called number is out of order.

Dial

The Express 3000 placed a call on either the first or second channel. The number called is displayed following the message.

Disconnect

The call on either the first or second channel was disconnected from the network. The far-end phone number is displayed if

available. Ensure flow control setting match on both terminal adapters.

Disconnect Req

Far-end unit disconnected during BONDING negotiation.

DTR not up

Express 3000 tried to place a call in a dialing mode that requires DTR to be in an active state, but it is not.

Dump call

The Express 3000 could not accept an incoming call because it was already involved in a call.

Dump

An incoming call on either the first or second channel was discarded by the Express 3000. The calling number is displayed if available.

ED_MISMATCH

Call is connected to different end point device. Call ISP.

FACILITY_NOT_IMPLEMENT

The network does not support the requested supplementary service.

FACILITY_NOT_SUBSCRIBED

The channel type requested has not been subscribed.

FACILITY_REJECTED

A facility requested by the user cannot be provided by the network.

Factory Reset 0

Unit defaulted to factory configuration.

FlowCtl mismatch

Bonding negotiation determined a flow control mismatch.

FlowCtl required

Bonding negotiation determined that flow control needs to be optioned on.

Hangup

The call on either the first or second channel was disconnected by the Express 3000. The far-end phone number is also displayed.

Hold

Voice call is on hold.

ID = XXXX

Calling party number.

INCOMING_CALL_BARRED

The network will not allow an incoming call.

INCOMPATIBLE_DEST

The called number cannot accept the type of call that has been placed.

INTERWORKING_UNSPEC

A non-ISDN network sent an unspecified message.

Inv Password

Remote configuration failed due to incorrect password.

INVALID_CALL_REF

Call control error.

INVALID_ELEM_CONTENTS

Call control error.

INVALID_MSG_UNSPEC

Invalid message; protocol error.

INVALID_NUMBER_FORMAT

The dialed number has an invalid format.

L1 not up

The network interface is not active.

L2 not up

The data link layer interface is not active.

L3 not up

The call control interface is not active.

L2 #2 not up

The data link layer interface for a second call (BONDING) is not active.

L3 #2 not up

The call control layer interface for a second call (BONDING) is not active.

LDN TOO LONG

The local directory number entered has too many digits.

Login failed

Unable to connect to remote unit on remote configuration attempt.

MANDATORY_IE_LEN_ERR

Mandatory information element length error.

MANDATORY_IE_MISSING

Mandatory information element missing.

MULTILINK PPP UP

Unit connected with Multilink PPP.

Need 64K call

The BONDING protocol requires the Express 3000 to be configured for 64K data call types.

NETWORK BUSY

The ISDN switch is busy and unable to process a call.

NETWORK_CONGESTION

The phone network is currently congested.

NETWORK_OUT_OF_ORDER

The phone network is out of order.

No calling ID

Calling party number not provided.

NO_CIRCUIT_AVAILABLE

The requested bearer channel is not available.

NONEXISTENT_MSG

Nonexistent/undefined message received from network.

NO_ROUTE_DEST

The phone network was unable to find a route to the destination number.

No Sreg number

Attempted to change an S-register but did not specify a specific S-register (example: ATS=1).

No Sreg value

Attempted to change an S-register but did not specify a value (example: ATS=).

No String Space

Stored number string space is full.

NO_USER_RESPONDING

The dialed number is not responding.

NORMAL_CLEARING

The network is disconnecting the current call.

NOT end2end ISDN

The path that the call was routed over is not ISDN from end-to-end (warning only).

NUMBER_CHANGED

The number dialed has been changed.

OUTGOING_CALL_BARRED

The network will not allow the outgoing call to be placed.

Phone # Req'd

Phone number required for AutoSpid determination.

PPP COMPRESSION UP

Unit connected with compression.

PPP LINK LOOPBACK

Network link is looped backed.

PPP Timeout

PPP negotiation failed.

PROTOCOL_ERROR

Call control error.

PUMPIO: dpump-quit

Rate adaption stopped due to DTE error.

Rcv Cause XXX

Undefined cause message received.

REQ_CHANNEL_NOT_AVAIL

The channel type requested is currently not available.

Remote not ISU

Bonding negotiation determined the far-end unit is not another ISU product.

RESOURCE_UNAVAIL

The requested resource is unavailable.

RESP_TO_STAT_ENQ

Response to status enquiry.

Restarting Rate

Unit restarts DTE rate.

Retrieve

Voice call is retrieved from a holding state.

Ring

An incoming call on either the first or second channel (third channel if call waiting) entered the Ring state. The calling phone number is displayed if available.

S cmd not = or ?

Proper syntax not used.

SERVICE_NOT_AVAIL

The requested service is not available.

SOURCE NOT ISDN

The incoming calling party is not ISDN (warning only).

TANULL expired

Bonding timer TANULL expired. Received call from non-BONDING equipment.

TEMPORARY_FAILURE

The network has temporarily failed; try the call again.

TIMER_EXPIRY

Call control error.

TXADD01 expired

Bonding timer TXADD01 expired.

TXDEQ expired

B-channel delay equalization during bonding failed.

TXFA1 expired

Bonding timer TXFA1 expired.

TXFA2expired

Bonding timer TXFA2 expired.

TXINIT expired

Bonding timer TXINIT expired; called non-BONDING equipment.

UNASSIGNED_NUMBER

The phone number dialed does not exist.

Unknown AT cmd

User issued an unknown AT command.

USER_ALERT_NO_ANS

Ringing call is not answered.

USER_BUSY

The dialed number is busy.

V120 connected

The V.120 rate adaption successfully connected to the far-end unit.

V120 Timeout

V.120 negotiation failed.

WRONG_MESSAGE

Call control error.

WRONG_MSG_FOR_STATE

Call control error.

Appendix C Loop Status Messages

This appendix lists the status line messages and their definitions.

AutoSpid X

The SPID is being attempted by the AutoSpid determination. X starts at 0 and counts up for each SPID tried.

Call Connect B1

Bearer channel 1 is connected and is active.

Call Connect B2

Bearer channel 2 is connected and is active.

Call Connect B1/B2

Bearer channels 1 and 2 are active.

Disconnecting

The current phone call is being disconnected (hung up).

Getting TEI #1

The Express 3000 is receiving its first TEI from the network.

Getting TEI #2

The Express 3000 is receiving its second TEI from the network.

Link Down

The network interface is not in sync.

Network Loopback

The Express 3000 has been commanded to perform an ISDN loopback toward the network.

Ready

The unit is ready to make or accept a call.

Register SPID #1

The Express 3000 is registering its first SPID with the network.

Register SPID #2

The Express 3000 is registering its second SPID with the network.

Ringling

The phone number just dialed is ringing.

xxxxx nnnn

A rate adaption is running at the bit rate specified by nnnn.

xxxxx Quitting

A rate adaption protocol is turning off.

xxxxx Ready

A rate adaption protocol is ready.

xxxxx Setup

A rate adaption protocol is setting up.

YYYY

ISDN switch-type selected.

xxxxx can be any of the following:

Bonding

Bandwidth on demand industry users group protocol.

PPP

Point-to-point rate adaption protocol.

V120

V.120 rate adaption protocol.

Appendix D Connector Pinouts

This appendix describes the various connector pinouts used with the Express 3000. Figure D-1 shows the EIA-232 interface and Table D-1 shows the EIA-232 pinout.

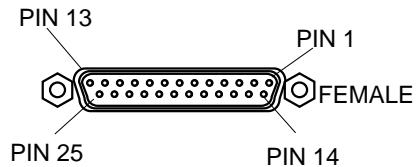

Figure D-1. EIA-232 Interface

Table D-1. EIA-232 Interface Pinout

Pin	Name	I/O	Description
1	Shield	I/O	Shield for Cable
2	TD	I	Transmitted Data
3	RD	O	Received Data
4	RTS	I	Request to Send
5	CTS	O	Clear to Send
6	DSR	O	Data Set Ready
7	SG	I/O	Signal Ground
8	CD	O	Carrier Detect
20	DTR	I	Data Terminal Ready
22		I	RI

I = Input O = Output

Figure D-2 shows the modem interface and Table D-2 shows the modem interface pinout.

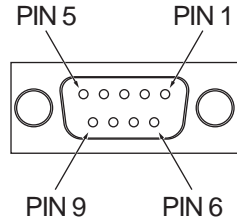

Figure D-2. Modem Interface

Table D-2. Modem Interface Pinout

Pin	Name	I/O	Description
1	CD	O	Carrier Detect
2	RXD	O	Received Data
3	TXD	I	Transmitted Data
4	DTR	I	Data Terminal Ready
5	SG	I/O	Signal Ground
6	NC	-	No Connection
7	RTS	I	Request to Send
8	CTS	O	Clear to Send
9	NC	-	No Connection

Figure D-3 shows the RJ-11 POTS port interface. For the POTS 1 interface, pin 3 is Ring and pin 4 is Tip. For the POTS 2 interface, pin 3 is Ring 2 and pin 4 is Tip 2.

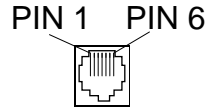

Figure D-3. RJ-11 POTS Port Interface

Figure D-4 shows the RJ-45 ISDN line interface. Pin 4 is Ring and pin 5 is Tip.

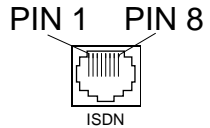

Figure D-4. RJ-45 ISDN Line Interface

Figure D-5 shows the power supply for the Express 3000.

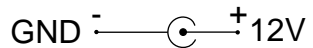

Figure D-5. Express 3000 Power Supply

Appendix E Acronyms and Abbreviations

AC.....	alternating current
AO/DI.....	Always On Dynamic ISDN
ATS.....	AT commands
BACP.....	Bandwidth Allocation Control Protocol
BERT.....	bit error rate test
BONDING... ..	Bandwidth on Demand Industry User Group Protocol
BPS.....	bits per second
CD.....	carrier detect
CPE.....	Customer Premises Equipment
CTS.....	clear to send
DCE.....	data-circuit terminating equipment
DIP.....	dual-inline pin
DN.....	directory number
DSR.....	data set ready
DTE.....	data terminal equipment
DTR.....	data terminal ready
FCC.....	Federal Communications Commission
GUI.....	graphical user interface
IRQ.....	interrupt request
ISDN.....	Integrated Services Digital Network
ISP.....	Internet Service Provider

kbps	kilobits per second
LCD	liquid crystal display
LDN	local directory number
LED	light emitting diode
LN	load number
Mbps	megabits per second
NC	no connection
POTS	plain old telephone service
PPP	Point-to-Point Protocol
RD	received data
REN	ringer equivalence number
RTS	request to send
RX	receive
RXD	receive data
SG	signal ground
SPID	service profile identifiers
TD	transmitted data
TEI	terminal endpoint identifier
TX	transmit
TXD	transmit data
UART	universal asynchronous receiver/transmitter
Y2K	Year 2000

Always On Dynamic ISDN (AO/DI)

A technology that allows a virtual connection to a corporate network or to the Internet while conserving costs by transmitting over the low bandwidth D channel. As bandwidth demand increases, B channels are added and then dropped as bandwidth requirement decreases.

AT commands

A set of commands that allows a computer to take control of a modem and to retrieve information from a modem. AT stands for *attention* and precedes each command.

Bandwidth Allocation Control Protocol (BACP)

In ISDN, a protocol that controls the addition and removal of channels from a multichannel link.

bit error rate test (BERT)

A diagnostic tool used to test data integrity by transmitting a known pattern of bits and then evaluating the subsequent bit error rate.

Bandwidth on Demand Industry User Group Protocol (BONDING)

A set of protocols that improves interoperability among multiplexers from various vendors. BONDING describes a number of interoperability modes for switched networks so that a sideband signal can be subdivided into multiple 56 kbps or 64 kbps channels and then recombined at the receiving end.

carrier detect (CD)

A signal generated by a modem which operates over phone lines to indicate whether the phone carrier is present and the line can be dialed.

Customer Premises Equipment (CPE)

Communication equipment residing on the end-user's side of the network interface boundary. In the U.S., end-user equipment that may not be owned by the local exchange. Examples include telephones and modems.

data communications equipment (DCE)

A category of devices which typically includes modems and printers. DCEs interface with DTEs.

datagram

A Layer 3 data construct in which the datagram header contains source destination addresses for routing purposes.

data terminal equipment (DTE)

User terminal equipment which creates information for transmission, for example, a user's PC.

data-circuit terminating equipment (DCE)

Carrier's equipment that is the DTE's interface to the network.

DIP switch

A very small toggle switch. The Express 3000 contains two DIP switches: one for changing data rates and one for resetting default parameters.

directory number

In the North American Numbering Plan, the last seven digits of a telephone number.

Federal Communications Commission

The U.S. federal regulatory agency responsible for the regulation of interstate and international communications by radio, television, wire, satellite, and cable.

graphical user interface (GUI)

A computer interface that permits users to directly manipulate objects which are displayed on the monitor. Using pointing devices (such as a mouse), the screen objects can be modified and controlled.

Integrated Services Digital Network (ISDN)

An international communications standard for digital transmission of data, voice, and video over telephone lines.

Internet Services Provider (ISP)

A company or organization that provides Internet access to the public or to other organizations, usually for a fee. Most offer a full set of Internet services (access to E-Mail, Newsgroups, FTP, and Telnet, at a minimum), and provide either hourly rates or a flat fee for a fixed number of hours of access.

interrupt request (IRQ)

A system of implementing computer processor interrupts (a suspension of one process to initiate another process--usually temporarily).

Local Directory Number

The seven digit telephone number assigned to the ISDN line.

Load Number (LN)

The Canadian equivalent to the U.S. Ringer Equivalence Number (REN) system (see also, Ringer Equivalence Number).

plain old telephone service (POTS)

The basic analog phone service. Does not include ISDN or calling features such as caller ID, etc.

Point-to-Point Protocol (PPP)

A standard method of transporting multiprotocol datagrams over point-to-point links. PPP facilitates connections through a wide variety of hosts, bridges, and routers. PPP is intended for simple, bidirectional, full duplex links transporting packets between peers.

Ringer Equivalence Number (REN)

A number assigned to an individual piece of telephone equipment indicating that the unit has met certain requirements and guidelines. If several units are using the same line, the total value of the REN should not exceed 5.0 (see also Load Number).

Service Profile Identifier (SPID)

A unique number representing the configuration of services and features of a particular ISDN user. The service provider assigns one SPID to each LDN being installed. The SPID identifies the ISDN terminal equipment to the ISDN switch at the carrier site.

terminal endpoint identifier (TEI)

An ISDN terminal device's Layer 2 address as defined in the LAPD protocol. It is unique on a passive bus and is used to establish independent data links between the switch and each device on the bus.

universal asynchronous receiver/transmitter (UART)

An integrated circuit device that receives serial data and converts it into parallel form for transmission, and vice versa.

V.120

A 1996 standard for ISDN support of DTE with V-series interfaces with provision for statistical multiplexing.

X.25

Definition of the interface between user's DTE and public packet DCE. Over a single physical link, an X.25 user can establish multiple virtual circuits (either switched or permanent) each with its own logical channel number, to different destinations.

Index

A

- add time 3-15
- adding channels 3-14
- analog devices
 - connecting 2-10
 - supplemental 2-10
- analog devices supported 1-2
- analog modem
 - 230.4 kbps unsupported 7-4
 - and terminal emulation 7-5
 - carrier detect 7-6
 - carrier detect signal 7-4
 - connecting
 - internal 7-7
 - disable using
 - terminal emulation 7-6
 - enable using
 - terminal emulation 7-5, 7-6
 - installing 7-1
- AO/DI
 - description 1-1
 - enabling 3-14
- area code, setting 3-8
- AT commands A-1
 - dialing a call A-3
 - disconnecting a call A-3
 - list A-4
 - using A-2
- auto answer 3-18
 - disabled 3-18
 - dump all calls 3-18
 - enabled 3-18
- auto-detect
 - switch 8-5
- available channels 3-15

B

- B1 and B2 LEDs, off 8-2
- BACP 3-12
- blinking green LEDs 2-4
- BONDING
 - specifications 3-15
 - TANULL 3-16
 - TCID 3-16
 - TXADD01 3-16
 - TXDEQ 3-16
 - TXFA 3-15
 - TXINIT 3-15
 - type 3-15

C

- call conference code 3-9
- call conferencing 5-1
- call forwarding 5-2
- call reject 5-2
- call rejection 3-16
- call rejection list, voice 3-17
- call rejection, anonymous 3-17
- call return 5-2
- call routing 3-14
 - all calls to DTE 3-14
 - speech calls to POTS 3-14
 - speech/audio calls to POTS 3-14
- call transfer code 3-10
- call type 3-13
 - audio 3-13
 - data 56kbps 3-13
 - data 64kbps 3-13
 - speech 3-13
- call waiting 5-3
 - controlling the tone 5-3
 - disabling 3-18
 - enabling 5-3

- caller ID 5-2
 - using 3-27
 - calling features 5-1
 - capture COM port 3-4
 - carrier detect signal 7-4
 - channels
 - adding 3-14
 - available 3-15
 - dropping 3-15
 - closing the Express configuration program 3-3
 - configuration program, customizing 3-26
 - configure DTE settings 2-9
 - configuring an external analog modem 7-4
 - connecting
 - external analog modem 7-3
 - internal analog modem 7-7
 - supplemental devices 2-10
 - connecting hardware
 - Macintosh 2-6
 - Windows 2-2
 - connecting the Express 3000
 - Macintosh 2-1
 - Windows 2-1
 - connecting the primary telephone 2-11
 - controlling the external analog modem 7-5
 - customizing the configuration program 3-26
- D**
- data call type 3-13
 - 56kbps 3-13
 - 64kbps 3-13
 - audio 3-13
 - speech 3-13
 - data over voice 3-14
 - detecting a connection 3-26
 - detecting a unit on startup 3-27
 - diagnostics
 - using 3-23
 - using terminal software for 3-27
 - dialing a call with AT commands A-3
 - dial-up connection problems 8-4
 - DIP switches
 - configure DTE settings 2-9
 - factory settings 2-9
 - resetting the Express 3000 2-9
 - switch 1 2-9
 - switch 2 2-9
 - disabling call waiting 3-18
 - disconnecting calls using AT commands A-3
 - distinctive ringing 3-14
 - documentation, acquiring additional 1-4
 - drop time 3-15
 - dropping channels 3-15
 - DTR options 3-12
 - answer if on 3-12
 - AT command when off 3-12
 - idle when off 3-12
 - ignore DTR 3-12
- E**
- EIA-232 port 2-11
 - enable/disable modem 3-4
 - Express 3000
 - analog devices 1-2
 - factory default settings 3-5
 - features 1-2
 - front panel 2-7
 - physical description 2-7
 - rear panel 2-8
 - shipping contents 1-4
 - system requirements 1-3
 - customer-provided 1-3
 - Express configuration program 3-1
 - closing 3-3
 - opening 3-2
 - opening, Macintosh 3-3

opening, Windows 3-2
Express configuration software
 description 1-1
 registration information 3-30
 tray tool 3-3
 tray tool, launching 3-3
 version number 3-30
external analog modem
 configuring 7-4
 connecting 7-3
 controlling 7-5
 setup illustration 7-1
 using 7-1
external analog modem, controlling
 7-5

F

factory default settings 3-5
 restoring 3-5
features
 Express 3000 1-2
 remote access 1-2
flash/hook
 conference/transfer 3-18
flash/hook default
 call waiting 3-18
flow control 3-13
 hardware 3-13
 no control 3-13
 software 3-13

H

HyperTerminal, upgrading software
 using 6-3

I

installing
 analog modem 7-1
 Express 3000
 Macintosh 2-5

Windows 95/98 2-2
Windows NT 2-4
Express configuration software
 Macintosh 2-7
 Windows 2-4
internal analog modem 7-6
 connecting 7-7
Internet access protocols 3-6
ISDN profile window 3-7
 general tab 3-8
 area code 3-8
 disable SPID download 3-9
 NI1 conference feature 3-9
 NI1 message feature 3-10
 NI1 transfer feature 3-10
 phone numbers 3-9
 SPIDs 3-9
 switch type 3-8
 packet tab 3-10
 dial prefix 3-10
 packet DN 3-10
 packet size 3-10
 packet TEI 3-10
 RX window size 3-10
 TX window size 3-10
 preview tab 3-11
ISDN profiles 3-6
ISDN, ordering 1-4

L

LEDs 2-7
link down 8-5
local units
 diagnosing 3-24
 diagnosing connection problems 3-25
 displaying caller ID log buffer 3-24
 displaying current status 3-24
 launching terminal programs 3-25
 retrieving current settings 3-24
loop status messages C-1

M

Macintosh

- connecting the hardware 2-6
- installation procedure 2-5
- installing the Express configuration software 2-7

message waiting

- code 3-10
- indicator 5-4

O

on-line help, using 3-5

opening the Express configuration

- program 3-2
- Macintosh 3-3
- Windows 3-2

ordering an ISDN line 1-4

P

phone number allocation 2-11

phone numbers (ISDN), setting 3-9

pinouts D-1

placing unit back on-line 4-3

ports

- EIA-232 2-11
- POTS port 1 2-11
- POTS port 2 2-11

power/line LED

- flashes green 8-2
- off 8-2

preferences option 3-26

primary telephone, connecting 2-11

profiles 3-7

- copying 3-20
- creating new 3-19
- deleting 3-21
- exporting 3-22
- importing 3-22
- ISDN 3-6
- modifying 3-20
- reading from current 3-23

saving 3-19

understanding 3-6

user 3-6

using 3-7

program name 3-27

program parameters 3-27

protocols

internet access 3-6

remote access 3-7

protocols tab 3-14

R

rear panel interfaces 2-8

remote access protocols 3-7

remote password 3-17

remote units

configuring user profile 3-25

diagnosing 3-25

retrieving current settings 3-25

retrieving status buffer information 3-26

testing 3-25

resetting the Express 3000 2-9

restoring factory default settings 3-5

return authorization vii

return shipment, cost of vii

returning unit vii

S

safety instructions iii

shared ports 2-11

shipping contents 1-4

software, upgrading 6-1

SPID detection, disabling automatic 3-9

SPIDs remain at link down 8-5

SPIDs, setting 3-9

S-register strings A-3

S-registers A-1, A-2

changing A-3

changing a string A-3

- list A-4, A-9
- reading A-2
- reading strings A-3
- status buffer 4-3
 - messages 4-4, B-1
 - terminal 4-3
- supplemental analog devices 2-10
- supplementary voice services 2-11
 - call conferencing 5-1
 - call forwarding 5-2
 - call reject 5-2
 - call return 5-2
 - caller ID 5-2
- switch type, setting 3-8
- switches
 - settings 2-9
- system requirements 1-3
 - customer provided 1-3

T

- terminal menus
 - accessing 4-2
 - exiting 4-3
 - hot keys 4-2
 - status buffer 4-3
- terminal option 3-27
- terminal programs 3-25
- terminal software for diagnostics,
 - using 3-27
- test timeout 3-18
- toll saver 3-4
- tray tool
 - closing 3-3
 - icon 3-3
 - launching 3-3
 - menu 3-4, 3-30
 - about Express Configuration 3-4
 - capture COM port 3-4
 - enable/disable modem 3-4
 - exit 3-4
 - help on Express Configuration 3-4

- properties 3-4
- toll saver 3-4
- troubleshooting 8-1
 - 230.4 operation, difficulty with 8-7
 - auto-detect switch SPIDs remains at link down 8-5
 - dial-up connection problems 8-4
 - dial-up networking, difficulty with 8-7
 - Express 3000 not detected 8-6
 - external analog modem
 - not detected 8-6
 - PWR / LINE LED flashes, and 1 and 2 LEDs are off 8-2
 - PWR / LINE LED is off 8-2

U

- unit information 3-24
- unit status 3-24
- upgrading software 6-1
 - using HyperTerminal 6-3
 - using the express configuration software 6-1
- user profile window 3-11
 - advanced tab 3-17
 - auto answer 3-18
 - connect timeout 3-17
 - disable call waiting on POTS 1 and 2 3-18
 - flash/hook default 3-18
 - inactivity timer 3-17
 - remote password 3-17
 - test timeout 3-18
 - V120 lower layer compatibility 3-17
 - diagnostics 3-23
 - general tab 3-12
 - call routing 3-14
 - data call type 3-13
 - data over voice 3-14
 - disable BACP 3-12
 - DTR options 3-12

- enable bandwidth on demand 3-12
- enable distinctive ringing 3-14
- flow control 3-13
- PPP Mode 3-12
- protocol 3-12
- phone list tab 3-16
 - allow only stored numbers 3-16
 - enable anonymous call rejection 3-17
 - enable call rejection list 3-16
 - incoming voice call rejection list 3-17
 - stored numbers 3-16
- preview tab 3-18
- protocols tab 3-14
 - add time 3-15
 - available channels 3-15
 - drop time 3-15
 - enable AO/DI 3-14
 - lower threshold 3-15
 - raise threshold 3-14
 - TANULL (bonding) 3-16
 - TCID (bonding) 3-16
 - TXADD01 (bonding) 3-16
 - TXDEQ (bonding) 3-16
 - TXFA (bonding) 3-15
 - TXINIT (bonding) 3-15
 - type (bonding) 3-15
- user profiles 3-6
- using the Express Configuration program 3-2

V

- voice services 2-11
- VT-100 terminal emulation 3-30, 4-1
 - configuration 4-3
 - configuring the Express using 4-1
 - status buffer 4-3

W

- warranty vii
- Windows
 - connecting the hardware 2-2
 - installing the Express configuration software 2-4
- Windows 95/98
 - installing Express 3000 2-2
- Windows NT
 - installing the Express 3000 2-4
- wizard
 - area code 3-28
 - automatically running on startup 3-30
 - ISDN phone numbers 3-28
 - SPIDs 3-29
 - switch type 3-29
 - using 3-28

Y

- Y2K iii

On-Line Services

ADTRAN Internet Homepage

<http://www.adtran.com>

The ADTRAN Internet homepage contains an ISDN Info Desk with the following information:

- General product information
- Modem scripts for popular software applications
- Frequently asked questions (FAQs) about common telecommunication issues
- Set up information for ADTRAN ISDN products

Technical Support

support@adtran.com

Electronic mail technical support allows customers to ask general questions and post noncritical technical support issues about ADTRAN products and services. Expect a 24-hour response time.

Fax Service: 256-963-7941

Submit field support questions by fax to this number.

FAXBack Service: 256-963-8200

Call this number and follow the simple instructions to have the ADTRAN documentation and support notes you need faxed back to you.

Pre-Sales Inquiries and Application Support

For Reseller or End-User

Based on the information needed, please contact your local Distributor, Dealer, or Reseller first. If they are unable to assist you, call Applications Assistance at (800) 615-1176 for product usage questions or Inside Sales at (800) 827-0807 for list price, availability, and purchase locations nearest you.

Post-Sales Support

For Reseller or End-User

Based on the information needed, please contact your local Distributor, Dealer, or Reseller first. If they are unable to assist you, call ADTRAN Technical Support at (888) 4-ADTRAN and have the unit serial number available.

